

THREE STAGE HEAVY OIL BURNERS

► PRESS T/N - T/N ECO SERIES

► P 140 T/N	320/800 ÷ 1600 kW
► P 200 T/N	515/1140 ÷ 2280 kW
► P 300 T/N	626/1710 ÷ 3420 kW
► P 450 T/N	855/2560 ÷ 5130 kW
► P 140 T/N ECO	320/800 ÷ 1600 kW
► P 200 T/N ECO	515/1140 ÷ 2280 kW
► P 300 T/N ECO	626/1710 ÷ 3420 kW
► P 450 T/N ECO	855/2560 ÷ 5130 kW

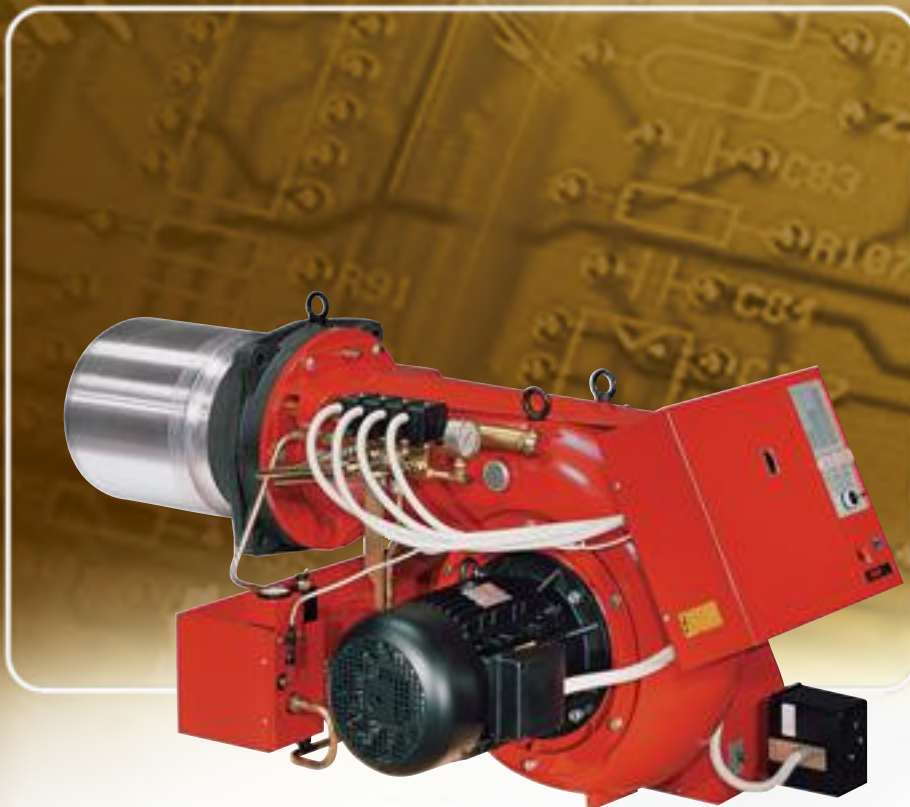

The PRESS T/N series of burners covers a firing range from 320 to 5130 kW. They have been designed in three versions for use in commercial and industrial installations, to burn different oil viscosity from 7 up to 60 °E @ 50°C. Operation is three-stage, thus making these burners suitable for installations that have variable but predictable heating requirements. A servomotor adjusts automatically air damper to the opening value, determined to obtain always the necessary fuel consumption. Every model of PRESS T/N series is available in two different combustion head length (short or long head) to be selected on the basis of specific application requirements. An electric preheater has been fitted to maintain the oil at the correct atomising temperature at maximum output and special heaters kits are separately supplied for burning high viscosity oil. Simplified maintenance is achieved by the Riello designed slide bar system, which allows easy access to all of the essential components of the combustion head.

TECHNICAL DATA

Model		▼ P 140 T/N	▼ P 200 T/N	▼ P 300 T/N	▼ P 450 T/N
Burner operation mode		Three stage			
Modulating ratio at max. output		2 : 1			
Servo-motor	type	LKS 210			LKS 300
	run time	5			4
Heat output	kW	320/800÷1600	515/1140÷2280	626/1710÷3420	855/2560÷5130
	Mcal/h	275/688÷1376	443/980÷1961	538/1471÷2941	727/2202÷4412
	kg/h	28/70÷140	45/100÷200	55/150÷300	75/224÷450
Working temperature	°C min./max.	0/40			
Net calorific value	kWh/kg	11.4			
	kcal/kg	9800			
	MJ/kg	41			
Low viscosity version	mm ² /s (cSt)	50 @ 50°C			
Pump	type	E 7	E 7	TA 2	TA 3
	delivery	kg/h at 25 bar	340	340	470
Medium viscosity version	mm ² /s (cSt)	200 @ 50°C (with heavy oil kit already installed in factory)			
Pump	type	E 7	E 7	TA 2	TA 3
	delivery	kg/h at 25 bar	340	340	470
High viscosity version (ECO models)	mm ² /s (cSt)	450 @ 50°C (separate 1400 rpm pump + heavy oil kit + pipes heating cable already installed in factory)			
Pump	type	TA 2	TA 3	TA 4	TA 5
	delivery	kg/h at 25 bar	235	385	500
Atomised pressure	bar	25			
Fuel temperature	max. °C	60			
Fuel preheater		Yes			
Fan	type	Centrifugal - with forward curve blades			
Air temperature	max. °C	60			
Electrical supply	Ph/Hz/V	3/50/230 (±10%)		3N/50/230-400 (±10%)	
Auxiliary electrical supply	Ph/Hz/V	1/50/230 (±10%)			
Control box	type	RMO 88			
Total electrical power	kW	18,6	19,5	32	37
Auxiliary electrical power	kW	1,6	1,5	2,9	2,4
Heaters electrical power	kW	14	14	19,6	19,6
Protection level	IP	40			
Pump motor electrical power (*)	kW	0,55	0,55	0,75	1,1
Rated pump motor current (*)	A	3,1/1,8	3,1/1,8	3,7/2,1	4,7/2,7
Fan motor electrical power	kW	3	4	7,5	15
Rated fan motor current	A	13,5/8	16,4/9,5	30/17,5	50,2/29
Fan motor start up current	A	86/51	83/48	195/113	301/174
Fan motor protection level	IP	55			
Ignition transformer	type	230 V - 2x6,5 kV			
	V1 - V2 I1 - I2	2 A - 35 mA			
Operation		Intermittent (at least one stop every 24 h)			
Sound pressure	dB (A)	86,3	87	87,6	88,2
Sound power	W	--			
CO emission	mg/kWh	< 200			
Grade of smoke indicator	N° Bacharach	< 10			
C _x H _y emission	mg/kWh	--			
NO _x emission	mg/kWh	< 620			
Directive		89/336 - 73/23 EEC			
Conforming to		EN 267			
Certification		--	--	--	--

(*) For High viscosity versions only.

Reference conditions:

Ambient temperature: 20°C
 Barometric pressure: 1000 mbar
 Altitude: 100 m a.s.l.
 Noise measured at a distance of 1 m

Since the Company is constantly engaged in the production improvement, the aesthetic and dimensional features, the technical data, the equipment and the accessories can be changed.
 This document contains confidential and proprietary information of RIELLO S.p.A. Unless authorised, this information shall not be divulged, nor duplicated in whole or in part.



FIRING RATES

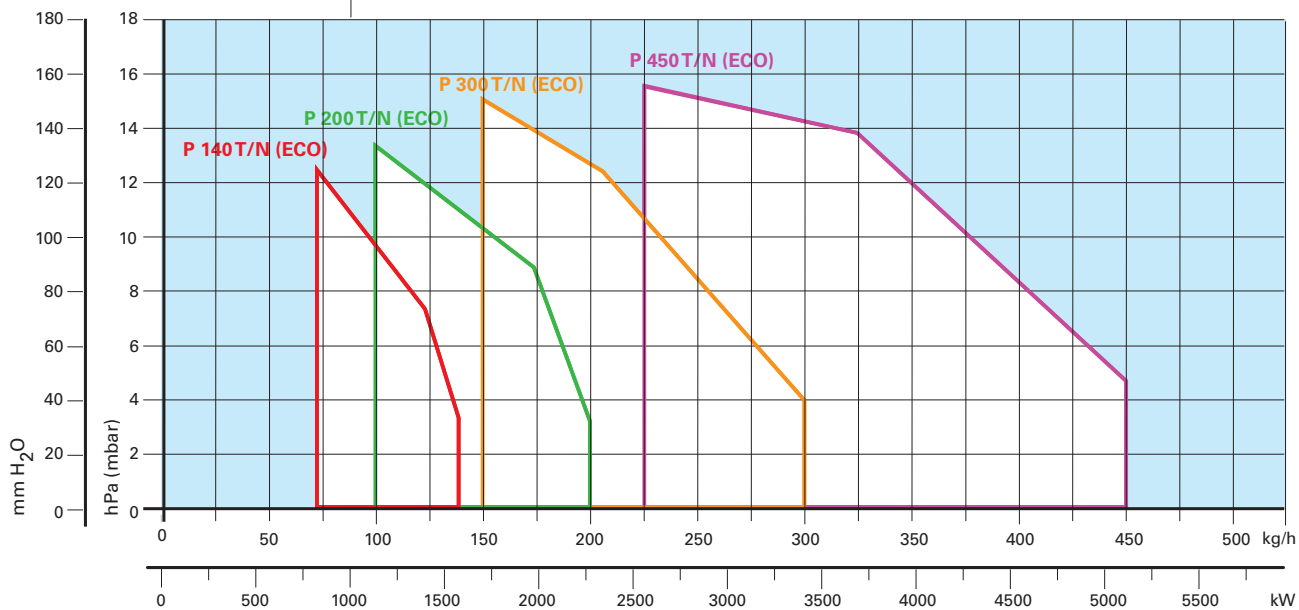

Useful working field for choosing the burner

Test conditions conforming to EN 267:

Temperature: 20°C
 Pressure: 1013.5 mbar
 Altitude: 100 m a.s.l.



FUEL SUPPLY

HYDRAULIC CIRCUIT

The burners are fitted with a valve group (a safety valve fitted in series with three oil delivery valves), an oil filter and an oil preheater unit along the oil line from the pump to the nozzle.

A thermostatic control device, on the basis of required heat, regulates oil delivery valves opening, allowing heavy oil passage through the valves to the nozzles.

Delivery valves open contemporary to the air damper, controlled by a servomotor.

The pumping group is fitted with a pump, an oil filter and a regulating valve, that adjusts atomised pressure. This value is pre-set at 25 bar in the factory, but it can be changed (28 bar for higher viscosity oils) by adjusting pressure regulator fitted on the pump.

The preheater unit is fitted with an electrical heater, a minimum and a maximum oil temperature switch and an oil temperature regulator.



Example of valve groups for burners of T/N series

prEN 267 > 100 Kg/h

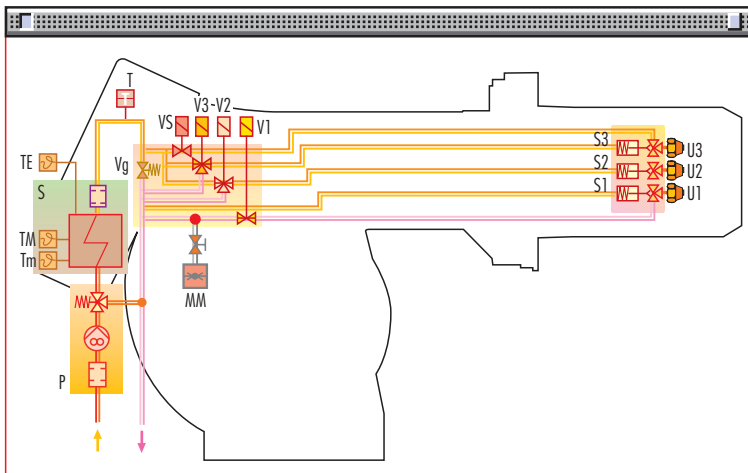

MM	Oil delivery gauge
P	Pump with oil filter
Tm	Min. oil temperature switch
TM	Max oil temperature switch
S	Oil pre-heater
TE	Oil temperature regulator
T	Thermometer
Vg	Oil pressure relief valve
VS	Safety valve
V1-2-3	Delivery oil valves
S1-2-3	Shutters
U1-2-3	Nozzles

VISCOSITY

The 3 stage burner series can burn different heavy oil type from 50 up to 450 cSt @ 50°C (7 up to 60°E @ 50°C).

For different viscosity levels Riello recommends 3 different configurations:

- 1) Press T/N version for viscosity up to 50 cST (7°E) @ 50°C: basic version with 2800 rpm oil pump installed directly on fan motor shaft
- 2) Press T/N version for viscosity up to 200 cST (25°E) @ 50°C: as basic version + heavy oil cartridges factory installed on nozzles, pump and valves group
- 3) Press T/N ECO version for viscosity up to 450 Cst (60°E) @ 50°C:
 - with separate 1400 rpm low speed pump
 - heavy oil cartridges factory installed on nozzles, pump and valves group
 - pipes heating cable factory installed

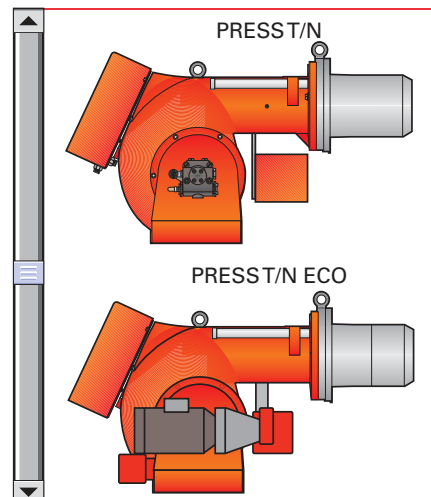



▶ SELECTING THE FUEL SUPPLY LINES

The fuel feed must be completed with the safety devices required by the local norms.

IMPORTANT NOTES

- The oil could easily flow through the pipes if those are properly sized, protected and heated (by electricity, steam or hot water)
- For starting-up: after excluding the burner by the shutter valves, let the oil flow into the supply ring up to reach the required circulation; after that open the valves and supply normally the burner.
- The forwarding pump should have at least a double capacity than that one of the burner. For several burners supplied through the same ring supply line, the forwarding pump should have a capacity of approximatively 30% more than the sum of the single burner output.

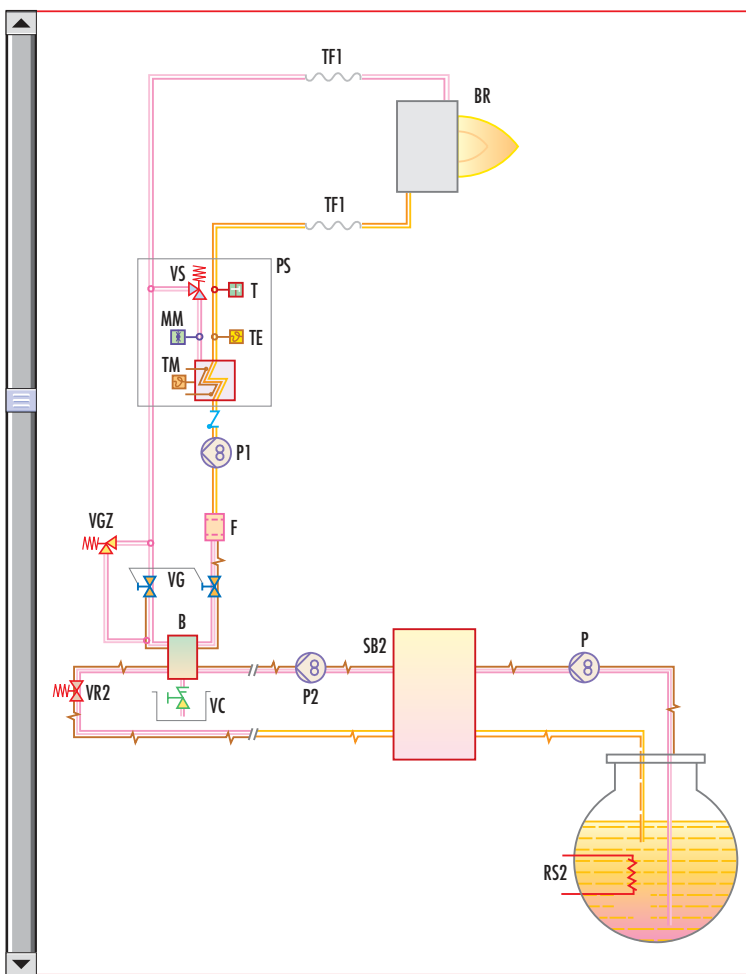

RS2	Tank heater
P	Double pumping unit with filter and heater on transfer ring
SB2	Service tank
P2	Double pumping unit with filter and heater on main ring
VR2	Oil valve – main ring
B	Gas separator bottle
VGZ	Safety valve – burner circuit
P1	Pump with heater – burner circuit
PS	Electrical preheater
VS	Preheater safety valve
BR	Burner
TF1	Flexible oil line
T	Thermometer
TM	Max oil temperature switch
TE	Temperature switch regulation
MM	Oil delivery gauge
VC	Vent valve
F	Oil filter





VENTILATION

The ventilation circuit comes with a forward blades centrifugal fan, which guarantees high pressure levels at the required air deliveries and permits installation flexibility.

In spite of the remarkable output power and of the very high pressure performances, PRESS T/N models are extremely compact. Sound proofing boxes help to reduce the noise level. A variable profile cam connects fuel and air setting, ensuring fuel efficiency in all firing rates.



Example of servomotor for burners of PRESS T/N series



COMBUSTION HEAD

Two different combustion head length can be selected for the various models of PRESS T/N series of burners.

The choice depends on the thickness of the front panel and type of boiler. Correct head penetration into the combustion chamber depends on the type of heat generator. The internal position of the combustion head can easily be adjusted: refer to the burner instruction manual for the complete procedure. The following diagram shows the flame dimensions in relation to the burner output. The length and diameter shown in the diagram below should be employed for a preliminary check: if combustion chamber dimensions are different from the values in the diagram, further tests need to be done.

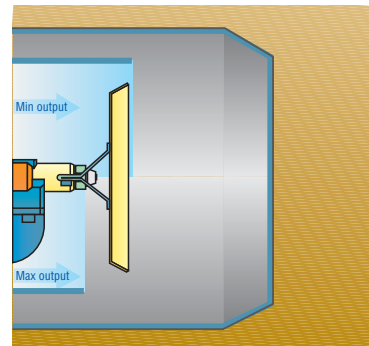

Example of a PRESS T/N burner combustion head

Flame dimensions

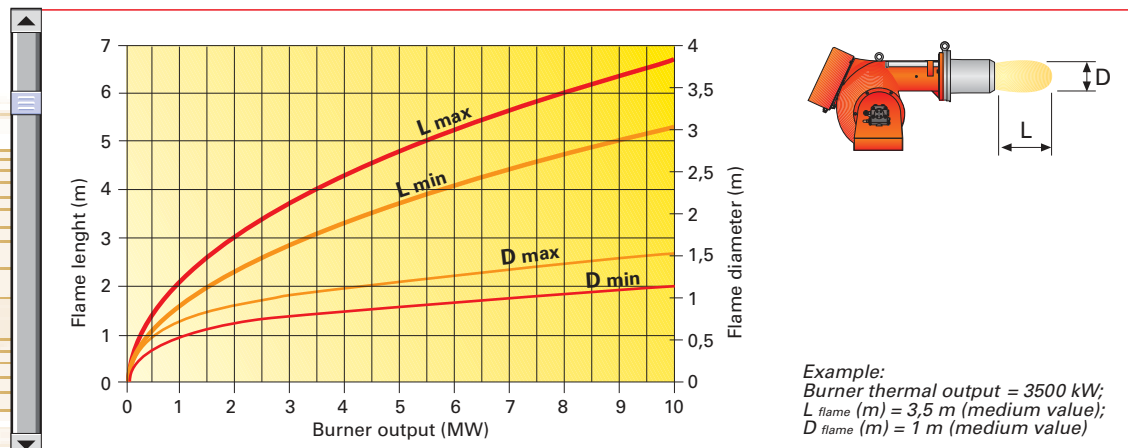

ADJUSTMENT



BURNER OPERATION MODE

With three stage operation, the PRESS T/N burners can follow the temperature load requested by the system.

A ratio between maximum and minimum working output of 3:1 is reached, thank to the servomotor: the air delivery is proportional to required output.

On three stage operation, the burner gradually adjusts output to the requested level, by varying between the three pre-set levels (see picture A).

Three stage operation

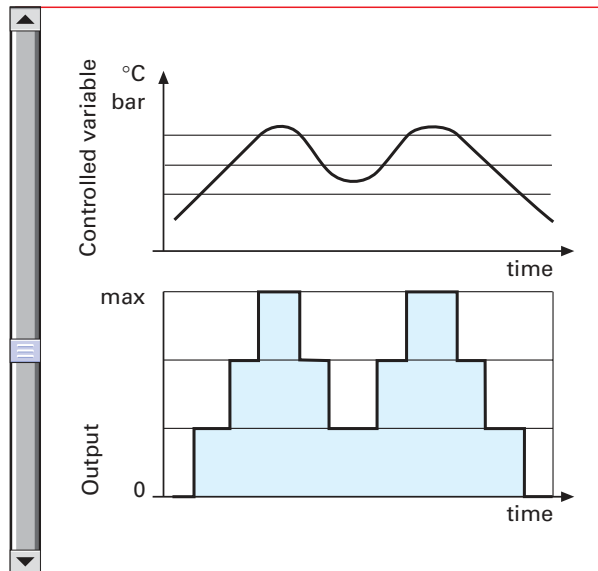

Picture A

In the table below operation, maximum output and fuel deliveries of the burners are shown.

Model	Stage	Max output (kW)	Max delivery (kg/h)
▶ P 140 T/N (ECO)	1 st	536	47
	2 nd	1060	93
	3 rd	1595	140
▶ P 200 T/N (ECO)	1 st	763	67
	2 nd	1516	133
	3 rd	2279	200
▶ P 300 T/N (ECO)	1 st	1140	100
	2 nd	2280	200
	3 rd	3420	300
▶ P 450 T/N (ECO)	1 st	1710	150
	2 nd	3420	300
	3 rd	5130	450



All PRESS T/N series burners are fitted with a new microprocessor control panel for the supervision during intermittent operation.

For helping the commissioning and maintenance work, there are two main elements:



The lock-out reset button is the central **operating element** for resetting the burner control and for activating / deactivating the diagnostic functions.



The multi-color LED is the central **indication element** for visual diagnosis and interface diagnosis.

Both elements are located under the transparent cover of lock-out reset button, as showed below.

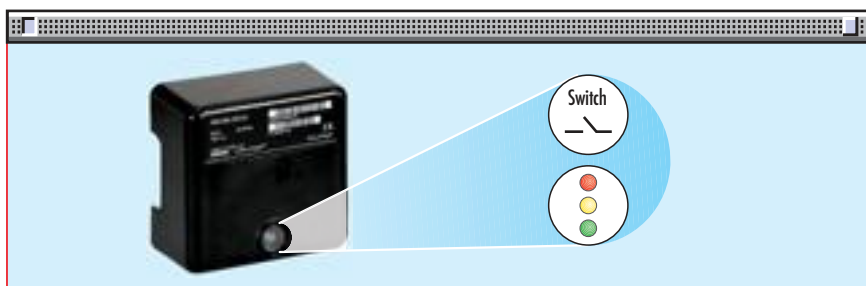

There are two diagnostic choices, for indication of operation and diagnosis of fault cause:

- visual diagnosis :

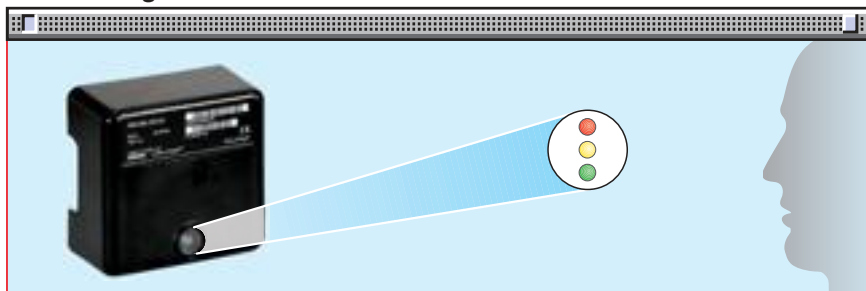

- interface diagnosis :

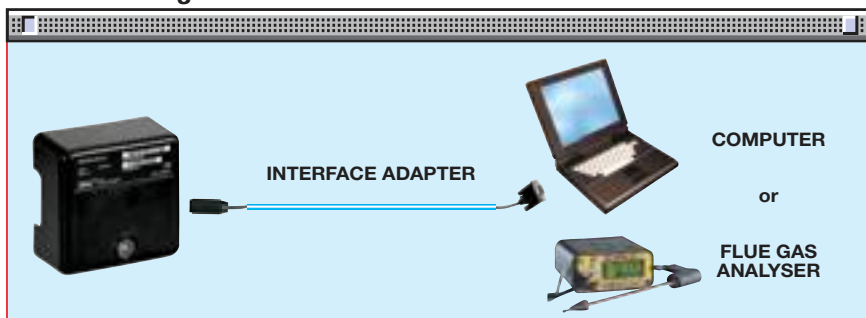

by the interface adapter and a PC with dedicated software or by a predisposed flue gas analyzer (see paragraph accessories).

Indication of operation :

In normal operation, the various statuses are indicated in the form of colour codes according to the table below.

The interface diagnosis (with adapter) can be activated by pressing the lock-out button for > 3 seconds.

Color code table	
Operation statuses	Color code table
Stand-by	○ ○ ○ ○ ○ ○ ○ ○
Pre-purging	☀ ☀ ☀ ☀ ☀ ☀ ☀ ☀
Ignition phase	☀ ○ ☀ ○ ☀ ○ ☀ ○
Flame OK	☀ ☀ ☀ ☀ ☀ ☀ ☀ ☀
Poor flame	☀ ○ ☀ ○ ☀ ○ ☀ ○
Undervoltage, built-in fuse	☀ ☀ ☀ ☀ ☀ ☀ ☀ ☀
Fault, alarm	☀ ☀ ☀ ☀ ☀ ☀ ☀ ☀
Extraneous light	☀ ☀ ☀ ☀ ☀ ☀ ☀ ☀

○ LED off



Diagnosis of fault causes:

After lock-out has occurred, the red signal lamp is steady on. In this status, the visual fault diagnosis according to the error code table can be activated by pressing the lock-out reset button for > 3 seconds. The interface diagnosis (with adapter) can be activated by pressing again the lock-out button for > 3 seconds.

The blinkers of red LED are a signal with this sequence:

(e.g. signal with n° 3 blinks – faulty air pressure monitor)



Error code table	
Possible cause of fault	Blink code
The flame does not stabilise at the end of the safety time: - faulty photocell - faulty or soiled oil valves - faulty ignition transformer - poor burner regulation	● ●
Not used	● ● ●
Light in the chamber before firing	● ● ● ●
Loss of flame during operations: - poor burner regulation - faulty or soiled oil valves	● ● ● ● ● ● ● ●
Faulty thermostat for oil permissive signal Heating resistances blown	● ● ● ● ● ● ● ● ● ●
Wiring error or internal fault	● ● ● ● ● ● ● ● ● ● ● ● ● ● ● ● ● ●

START UP CYCLE

P 140 T/N - P 200 T/N - P 300 T/N - P 450 T/N

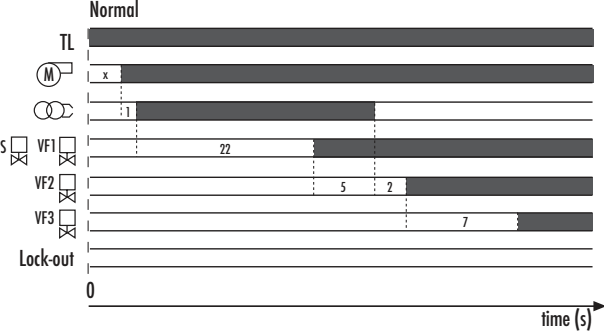

Start up procedure is referred to a three stage operation

- 0s The burner begins the start-up cycle: thermostat TL closes.
- Xs The motor starts running. Factory setting: 20s. This time determines the heavy oil temperature at ignition. It can be adjusted, according to the fuel's viscosity, by the timer. The adjacent diagram shows the suggested settings.
- 3s Ignition transformer turns on.
- 25s Solenoid security valve VS and 1st stage valve VF1 open: 1st stage flame.
- 30s Lock out takes place if flame is not revealed by the photocell. Otherwise ignition transformer switches off.
- 32s 2nd stage solenoid valve VF2 opens.
- 39s 3rd stage solenoid valve VF3 opens.

For alternatives start-up procedures, consult the instructions' manual.



WIRING DIAGRAMS

Electrical connections must be made by qualified and skilled personnel, according to the local norms.



Example of the terminal board for electrical connections for P 140-200-300-450 T/N models

“THREE STAGE” OPERATION

Direct start-up version P 140-200-300 T/N

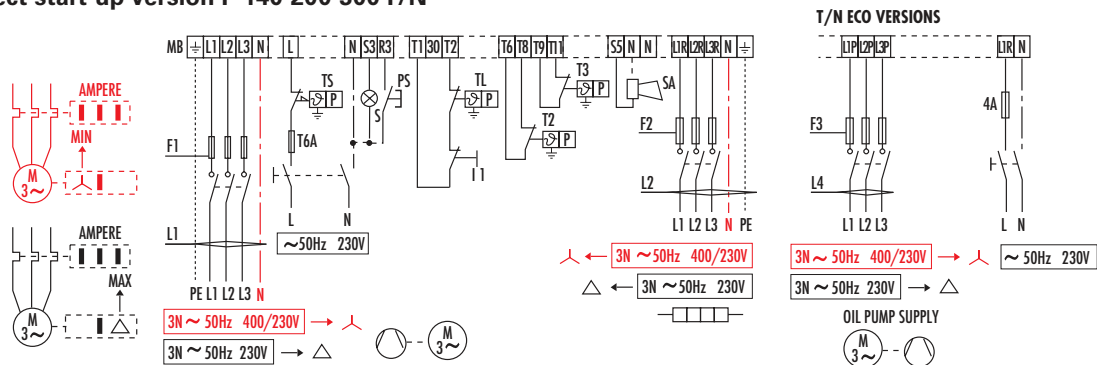

- MB** - Burner terminal board
- L1, L2, L4** - Lead section (see table A)
- TS** - Safety thermostat
- S** - External lock-out signal
- TL** - Threshold thermostat
- TR** - High/low flame setting thermostat
- T6A** - 6A fuse

- F1, F2, F3** - Fuse (see table A)
- I1** - Manual switch
- SA** - High temperature oil alarm
- T2** - 2nd stage load control system
- T3** - 3rd stage load control system
- PS** - Lock-out reset button

Star delta start-up version P 300-450 T/N

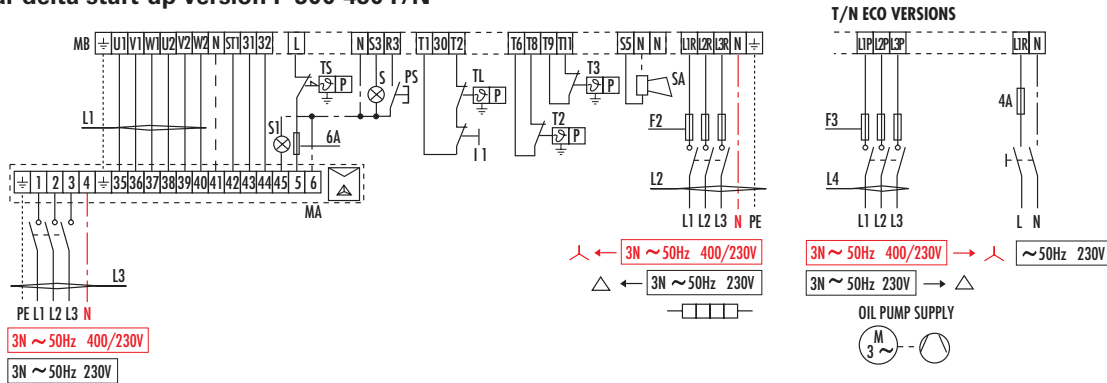

- MB** - Burner terminal board
- L2, L3, L4, H** - Lead section (see table A)
- TS** - Safety thermostat
- S, S2** - External lock-out signal
- TL** - Threshold thermostat
- TR** - High/low flame setting thermostat
- T6A** - 6A fuse

- F1, F2, F3** - Fuse (see table A)
- MA** - Star delta starter
- I1** - Manual switch
- SA** - High temperature oil alarm
- T3** - 3rd stage load control system
- T2** - 2nd stage load control system
- PS** - Lock-out reset button

The following table shows the supply lead sections and the type of fuse to be used.

Model	Direct						Star delta			
	P 140T/N		P 200T/N		P 300T/N		P 300T/N		P 450T/N	
F1 A	230V	400V	230V	400V	230V	400V	230V	400V	230V	400V
F2 A	T25	T25	T35	T25	T63	T50	-	-	-	-
F3 A	T50	T35	T50	T35	T63	T50	T63	T50	T63	T50
L1 mm ²	T10	T6	T10	T6	T10	T6	T10	T6	T10	T6
L2 mm ²	2,5	2,5	4	2,5	6	4	-	-	-	-
L3 mm ²	10	6	10	6	10	6	10	6	10	6
L4 mm ²	-	-	-	-	-	-	6	4	6	4
H mm ²	1,5	1,5	1,5	1,5	1,5	1,5	1,5	1,5	1,5	1,5
	-	-	-	-	-	-	4	2,5	6	4

EMISSIONS

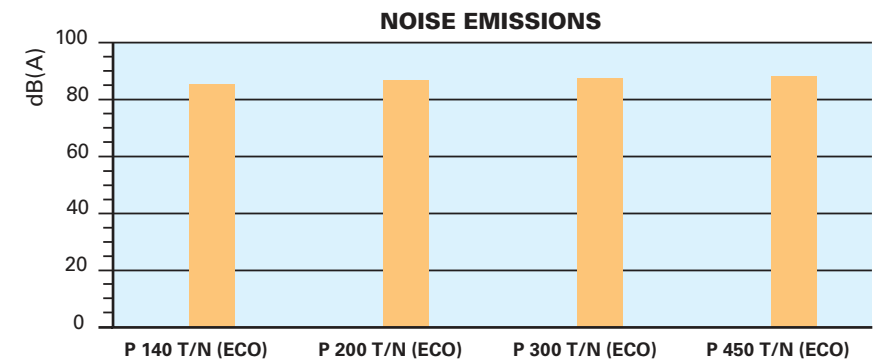
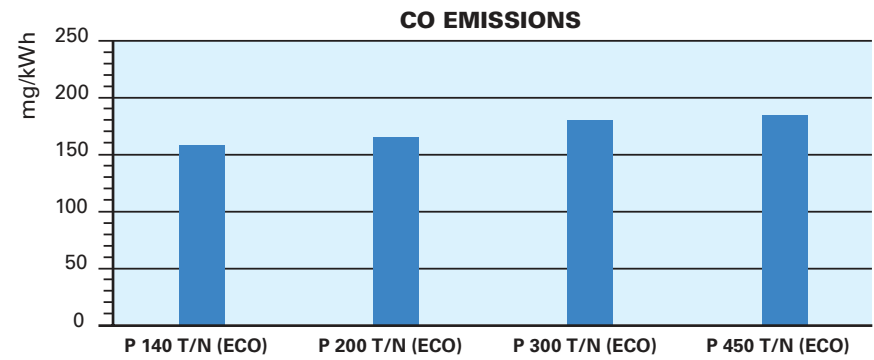
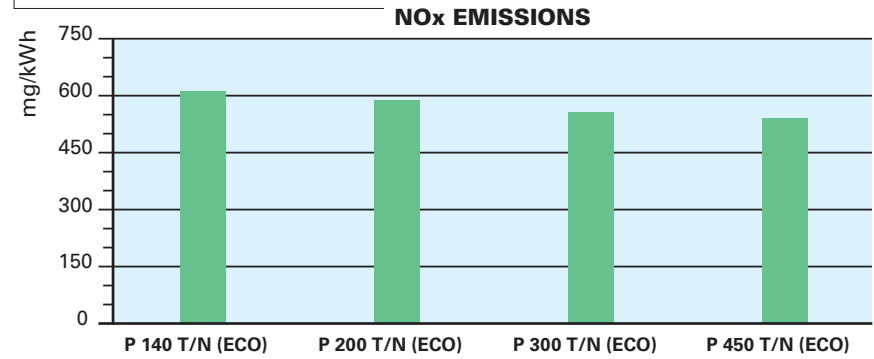
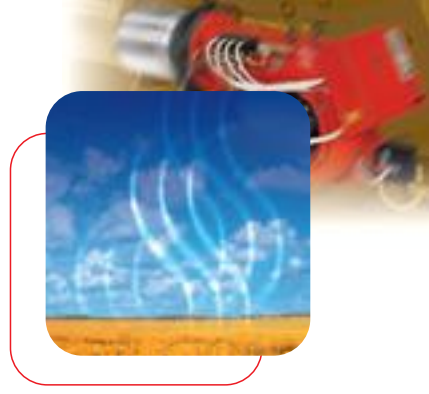

The emission data has been measured in the various models at maximum output, according to EN 267 standard.



OVERALL DIMENSIONS (mm)

BURNERS

PRESS T/N

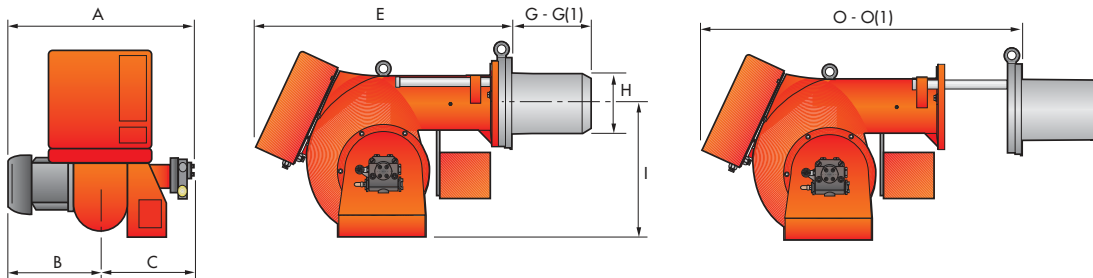

PRESS T/N ECO

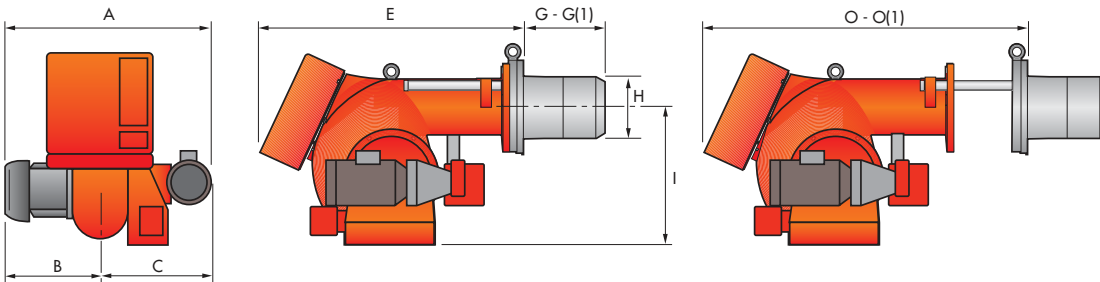

Model	A	B	C	E	G - G(1)	H	I	O - O(1)
▶ P 140T/N	796	396	400	890	323 - 433	222	467	1370 - 1370
▶ P 200T/N	796	396	400	890	352 - 462	250	467	1370 - 1370
▶ P 300T/N	858	447	411	1000	376 - 506	295	496	1515 - 1665
▶ P 450T/N	950	508	442	1090	435 - 565	336	525	1665 - 1820
▶ P 140T/N ECO	900	396	504	890	323 - 433	222	467	1370 - 1370
▶ P 200T/N ECO	900	396	504	890	352 - 462	250	467	1370 - 1370
▶ P 300T/N ECO	984	447	537	1000	376 - 506	295	496	1515 - 1665
▶ P 450T/N ECO	1100	508	592	1090	435 - 565	336	525	1665 - 1820

(1) Length with extended combustion head

BURNER - BOILER MOUNTING FLANGE

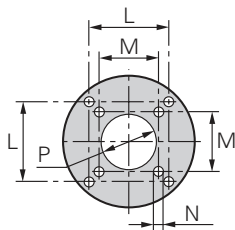

Model	L	M	N	P
▶ P 140T/N (ECO)	260	230	M 14	225
▶ P 200T/N (ECO)	260	-	M 16	255
▶ P 300T/N (ECO)	260	-	M 18	300
▶ P 450T/N (ECO)	310	-	M 20	350

PACKAGING

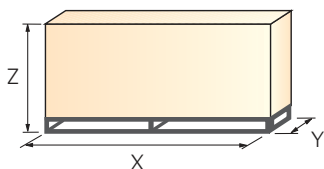

Model	X	Y	Z	kg
▶ P 140T/N (ECO)	1500	930	900	180
▶ P 200T/N (ECO)	1500	930	900	190
▶ P 300T/N (ECO)	1780	1085	990	260
▶ P 450T/N (ECO)	1780	1085	990	350

INSTALLATION DESCRIPTION



Installation, start up and maintenance must be carried out by qualified and skilled personnel.
All operations must be performed in accordance with the technical handbook supplied with the burner.



BURNER SETTING

- ▶ All the burners have slide bars, for easier installation and maintenance.
- ▶ After drilling the boilerplate, using the supplied gasket as a template, dismantle the blast tube from the burner and fix it to the boiler.
- ▶ Adjust the combustion head.
- ▶ Refit the burner casing to the slide bars.
- ▶ Install the nozzle, choosing this on the basis of the maximum boiler output and following the diagrams included in the burner instruction handbook.
- ▶ Check the position of the electrodes.
- ▶ Close the burner, sliding it up to the flange, keeping it slightly raised to avoid the flame stability disk rubbing against the blast tube.

HYDRAULIC AND ELECTRICAL CONNECTIONS AND START-UP

- ▶ The burners are supplied for connection to two pipes fuel supply system.
- ▶ Connect the ends of the flexible pipes to the suction and return pipework using the supplied nipples.
- ▶ Make the electrical connections to the burner following the wiring diagrams included in the instruction handbook.
- ▶ Prime the pump by turning the motor (after checking rotation direction if it is a three phase motor).
- ▶ On start up, check:
 - Pressure pump and valve unit regulator (to max. and min.)
 - Combustion quality, in terms of unburned substances and excess air.



BURNER ACCESSORIES

Available for T/N and T/N ECO versions

Nozzles

The nozzles must be ordered separately. The following table shows the features and codes on the basis of the maximum required output.



NOTE: each burner needs N° 3 nozzles.

Nozzles type F80 - PL 60°			
Burner	Rated delivery at 25 bar (kg/h)	GPH	Nozzle code
P 140 T/N	20,8	3,5	3043162
P 140 T/N	23,8	4	3043172
P 140 T/N	26,8	4,5	3043182
P 140 T/N - P 200 T/N	29,8	5	3043192
P 140 T/N - P 200 T/N	32,7	5,5	3043202
P 140 T/N - P 200 T/N	35,7	6	3043212
P 140 T/N - P 200 T/N	38,7	6,5	3043222
P 140 T/N - P 200 T/N	41,7	7	3043232
P 140 T/N - P 200 T/N	44,6	7,5	3043242
P 200 T/N - P 300 T/N	50,6	8,5	3043262
P 200 T/N - P 300 T/N	56,5	9,5	3043272
P 200 T/N - P 300 T/N - P 450 T/N	62,5	10,5	3043302
P 300 T/N - P 450 T/N	71,4	12	3043322
P 300 T/N - P 450 T/N	80,4	13,5	3043342
P 300 T/N - P 450 T/N	92,3	15,5	3043372
P 450 T/N	104,2	17,5	3043402
P 450 T/N	116,1	19,5	3043432
P 450 T/N	128	21,5	3043452
P 450 T/N	142,8	24	3043472

Spacer kit

If burner head penetration in the combustion chamber needs reducing, varying thickness spacers are available, as given in the following table.

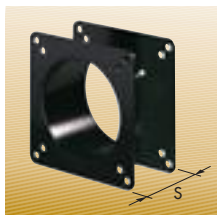

Spacers kit		
Burner	Spacer thickness S (mm)	Kit code
P 140 T/N - P 200 T/N	110	3000722
P 300 T/N	110	3000723
P 450 T/N	130	3000751



Sound proofing box

If noise emissions need reducing, sound proofing hoods are available, as given in the following table.



Sound proofing box			
Burner	Box type	Average noise reduction [dB(A)] (*)	Box code
P 140 T/N - P 200 T/N	C4/5	10	3010404
P 300 T/N - P 450 T/N	C7	10	3010376

(*) according to EN 15036-1 standard

Selfcleaning filter

For cleaning heavy oil from dirty particles and impurities, it is equipped with a thermostatic heater for oil with 60°E viscosity at 50°C.



Type	Filtering degree (µm)	Filter code
Ø=1" 1/2 (65°E at 50°C)	300	3010022

Heaters and thermostats	
Type	Heater/thermostat code
Thermostatic heater with LED	3010060
Heater	3010061
Thermostat (two-stage / regulable)	3010062

Degasing unit

It allows to recover heat in excess by discharge of the gas from the return circuit.



Degasing unit		
Burner	Filter	Degaser code
P 140 T/N - P 200 T/N	Without	3000748
P 300 T/N - P 450 T/N	Without	3010012

Heavy oil kit

Equipped with electrical heaters, it permits the employment of PRESS T/N burners with fuel oil of max. viscosity 25°E at 50°C.

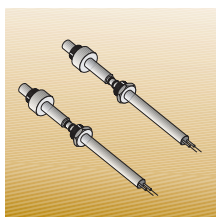

Heavy oil kit	
Burner	Kit code
P 140 T/N - P 200 T/N - P 300 T/N - P 450 T/N	3000721



Heavy oil precirculation kit

This kit, used with oil with high viscosity, in maintains fuel circulation in the oil circuit for avoiding system stop at start up.



Heavy oil precirculation	
Burner	Code
P 140 T/N - P 200 T/N	3000749
P 300 T/N - P 450 T/N	3000750

Burner support

For easier maintenance, a mobile burner support has been designed, which means the burner can be dismantled without the need of forklift trucks.

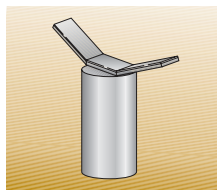

Burner support	
Burner	Support code
P 300 T/N - P 450 T/N	3000731

PC interface kit

To connect the flame control panel to a personal computer for the transmission of operation, fault signals and detailed service information, an interface adapter with PC software are available.



Interface adapter	
Burner	Kit code
P 140 T/N - P 200 T/N - P 300 T/N - P 450 T/N	3002719

SPECIFICATION



A specific index guides your choice of burner from the various models available in the PRESST/N series. Below there is a clear and detailed specification description of the product.

DESIGNATION OF SERIES

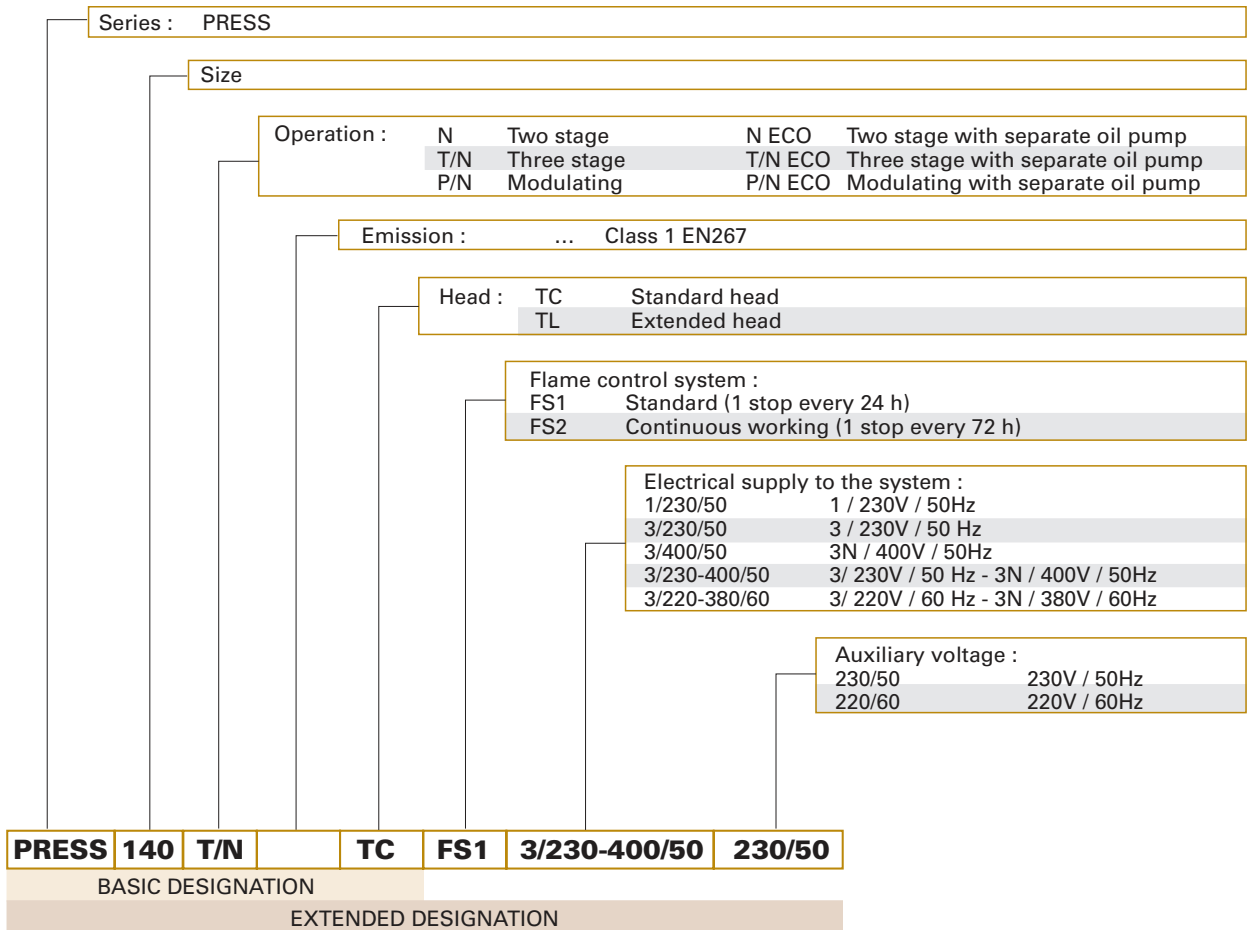

AVAILABLE BURNER MODELS

P 140	T/N (ECO)	TC	3/230-400/50	230/50
P 140	T/N (ECO)	TL	3/230-400/50	230/50
P 140	T/N (ECO)	TC	3/220-380/60	220/60
P 140	T/N (ECO)	TL	3/220-380/60	220/60
P 200	T/N (ECO)	TC	3/230-400/50	230/50
P 200	T/N (ECO)	TL	3/230-400/50	230/50
P 200	T/N (ECO)	TC	3/220-380/60	220/60
P 200	T/N (ECO)	TL	3/220-380/60	220/60
P 300	T/N (ECO)	TC	3/230-400/50	230/50
P 300	T/N (ECO)	TL	3/230-400/50	230/50

P 300	T/N (ECO)	TC	3/230/50	230/50
P 300	T/N (ECO)	TL	3/230/50	230/50
P 300	T/N (ECO)	TC	3/400/50	230/50
P 300	T/N (ECO)	TL	3/400/50	230/50
P 450	T/N (ECO)	TC	3/230/50	230/50
P 450	T/N (ECO)	TL	3/230/50	230/50
P 450	T/N (ECO)	TC	3/400/50	230/50
P 450	T/N (ECO)	TL	3/400/50	230/50

**Ask specific code for "ECO" models.
Other models are available on request.**





▶ PRODUCT SPECIFICATION

Burner:

Monoblock forced draught heavy oil burner, three stage operation, made up of:

- Air suction circuit
- Fan with forward curved blades
- Air dampers for air setting controlled by a servomotor
- Fan motor at 2850 rpm
- Combustion head, fitted with:
 - stainless steel end cone, resistant to corrosion and high temperatures
 - ignition electrodes
 - flame stability disk
- Gears pump for high pressure fuel supply, fitted with:
 - filter
 - pressure regulator
 - connections for installing a pressure gauge and vacuumeter
 - internal by-pass for single pipe installation
- Valve unit with a oil safety shut-off valve fitted in series with three valves controlling three-stage on the output circuit
- Heavy oil kit cartridges (for T/N version viscosity 7°E @ 50°C and for T/N ECO version)
- Pipes heating cable (T/N ECO version)
- Oil pump motor at 1400 rpm (T/N ECO version)
- Oil preheater
- Servomotor for air damper regulation
- Photocell for flame detection
- Flame control panel
- Flame inspection window
- Slide bars for easier installation and maintenance
- Protection filter against radio interference
- IP 40 electric protection level.

Conforming to:

- 89/336/EEC directive (electromagnetic compatibility)
- 73/23/EEC directive (low voltage)
- EN 267 (liquid fuel burners).

Standard equipment:

- 2 flexible hoses for pipe connection
- 2 nipples for flexible hoses
- 1 thermal insulation screen
- 4 screws for fixing the burner flange to the boiler
- 3 nozzles
- 2 extensions for bars (for long head version of P 300 T/N and P 450 T/N)
- 5 wiring looms for fittings for electrical connections (7 for P 450 T/N version)
- 1 star delta starter (only for P 450 T/N version)
- Instruction handbook for installation, use and maintenance
- Spare parts catalogue.

Available accessories to be ordered separately:

- Nozzles
- Head length reduction kit (spacer)
- Sound-proofing box
- Burner support
- Gas separator bottle
- Selfcleaning filter
- Heavy oil kit
- Heavy oil precirculation kit
- PC interface kit.





RIELLO S.p.A. - Via Ing. Pilade Riello, 5 - 37045 Legnago (VR) Italy
Tel. ++39.0442630111 - Fax ++39.044221980

Internet: <http://www.rielloburners.com> - E-mail: info@rielloburners.com

Since the Company is constantly engaged in the production improvement, the aesthetic and dimensional features, the technical data, the equipment and the accessories can be changed.
This document contains confidential and proprietary information of RIELLO S.p.A.
Unless authorised, this information shall not be divulged, nor duplicated in whole or in part.

