

TS0012UK05

RL/M Series

Modulating Light Oil Burners



RL 28/M	95/166	÷	332	kW
RL 38/M	101/237	÷	450	kW
RL 50/M	130/296	÷	593	kW
RL 70/M	261/474	÷	1043	kW
RL 100/M	332/711	÷	1482	kW
RL 130/M	498/948	÷	1779	kW
RL 190/M	534/1423	÷	2431	kW

The RL/M series of burners covers a firing range from 166 to 2431 kW, and they have been designed for use in hot or superheater water boilers, hot air or steam generators, diathermic oil boilers.

Operation can be "two stage progressive" or, alternatively, "modulating" with the installation of a PID logic regulator and respective probes. RL/M series burners guarantees high efficiency levels in all the various applications, thus reducing fuel consumption and running costs. Optimisation of sound emissions is guaranteed by the use of fans with forward inclined blades and sound deadening material incorporated in the air suction circuit.

The exclusive design ensures reduced dimensions, simple use and maintenance. A wide range of accessories guarantees elevated working flexibility.



Technical Data

MODEL		RL 28/M	RL 38/M	RL 50/M
Burner operation mode		Modulating (with regulator and probes accessories)		
Modulation ratio to max. output		3 ÷ 1		
Servomotor	type	SQN90		
	run time s	24		
Heat output	kW	95/166÷332	101/237÷450	130/296÷593
	Mcal/h	81,7/143÷286	87/204÷387	112/255÷510
	Kg/h	8/14÷28	8,5/20÷38	11/25÷50
Working temperature	°C min./max:	0/40		
FUEL/AIR DATA				
Net calorific value	kWh/kg	11,8		
	Kcal/kg	10200		
Viscosity at 20°C	mm ² /s (cSt)	4 ÷ 6		
Pump	type	AL 75C	AL 95C	AL 95C
	output kg/h at 20 bar	74	99	99
Atomised pressure	bar	20		
Fuel temperature	Max. °C	50		
Fuel pre-heater				
Fan	type	(01)	(01)	(01)
Air temperature	Max. °C	60		
ELECTRICAL DATA				
Electrical supply	Ph/Hz/V	(03)	(04)	(04)
Auxiliary electrical supply	Ph/Hz/V	(03)	(03)	(03)
Control box	type	LAL 1.25		
Total electrical power	kW	0,4	0,6	0,8
Auxiliary electrical power	kW	0,15	0,15	0,15
Heaters electrical power	kW			
Protection level	IP	44		
Pump motor electrical power	kW	--		
Rated pump motor current	A	--		
Pump motor start up current	A	--		
Pump motor protection level	IP	--		
Fan motor electrical power	kW	0,25	0,45	0,65
Rated fan motor current	A	2,1	2 - 1,2	3 - 1,7
Fan motor start up current	A	10	9,5 - 5,5	13,8 - 8
Fan motor protection level	IP	40	54	54
Ignition transformer	type			
	V1 - V2	230V - 2x5kV	230V - 2x5kV	230V - 2x5kV
	I1 - I2	1,9A - 30mA	1,9A - 30mA	1,9A - 30mA
Operation		(10)	(10)	(10)
EMISSIONS				
Sound pressure	dB(A)	68	70	75
Sound power	W	--		
CO emission	mg/kWh	< 40		
Grade of smoke indicator	N° Bach.	< 1		
CxHy emission	mg/kWh	<10 (after the first 20 s.)		
NOx emission	mg/kWh	< 200		
APPROVAL				
Directive		73/23 (2006/95) - 89/336 (2004/108) - 98/37 - 92/42 EEC		
According to		EN 267		
Certification		--		

(01) Centrifugal with reverse curve blades

(02) Centrifugal with forward curve blades

(03) 1/50/230-(±10%)

(04) 3N/50/400-(±10%) 3/50/230-(±10%) Δ

(05) Intermittent (at least one stop every 24 h)

(06) Intermittent (at least one stop every 24 h) - Continuous as optional (at least one stop every 72 h)

Reference conditions:

Temperature: 20°C - Pressure: 1013,5 mbar - Altitude: 0 m a.s.l. - Noise measured at a distance of 1 meter.

Since the Company is constantly engaged in the production improvement, the aesthetic and dimensional features, the technical data, the equipment and the accessories can be changed. This document contains confidential and proprietary information of RIELLO S.p.A. Unless authorised, this information shall not be divulged, nor duplicated in whole or in part.

MODEL	RL 70/M	RL 100/M	RL 130/M	RL 190/M
Burner operation mode	Modulating (with regulator and probes accessories)			
Modulation ratio to max. output	3 ÷ 1			
Servomotor	type	SQN31		
	run times	42		
Heat output	kW	261/474÷1043	332/711÷1482	498/948÷1779
	Mcal/h	224/408÷897	286/612÷1275	428/816÷1530
	Kg/h	22/40÷88	28/60÷125	42/80÷150
Working temperature	°C min./max.	0/40		
FUEL/AIR DATA				
Net calorific value	kWh/kg	11,8		
	Kcal/kg	10200		
Viscosity at 20°C	mm ² /s (cSt)	4 ÷ 6		
Pump	type	J 7C		TA 3
	output	kg/h at 20 bar	190	665
Atomised pressure	bar	20		
Fuel temperature	Max. °C	50		
Fuel pre-heater				
Fan	type	(01)	(01)	(01)
Air temperature	Max. °C	60		
ELECTRICAL DATA				
Electrical supply	Ph/Hz/V	(04)	(04)	(04)
Auxiliary electrical supply	Ph/Hz/V	(03)	(03)	(03)
Control box	type	LAL 1.25 (Intermittent working) - LOK 16 (Continuous working)		
Total electrical power	kW	1,4	2,1	2,6
Auxiliary electrical power	kW	0,3	0,3	0,4
Heaters electrical power	kW			
Protection level	IP	44		
Pump motor electrical power	kW	--		
Rated pump motor current	A	--		
Pump motor start up current	A	--		
Pump motor protection level	IP	--		
Fan motor electrical power	kW	1,1	1,8	2,2
Rated fan motor current	A	4,8 - 2,8	7,3 - 4,2	8,8 - 5,1
Fan motor start up current	A	25 - 14,6	37,6 - 21,8	57,2 - 33,2
Fan motor protection level	IP	54		
Ignition transformer	type	230V - 2x5kV		
	V1 - V2	1,9A - 30mA		1,9A - 35mA
Operation	I1 - I2	(06)	(06)	(06)
EMISSIONS				
Sound pressure	dBA	75	77	78,5
Sound power	W	--		
CO emission	mg/kWh	< 40		
Grade of smoke indicator	N° Bach.	< 1		
CxHy emission	mg/kWh	<10 (after the first 20 s.)		
NOx emission	mg/kWh	< 200		
APPROVAL				
Directive	73/23 (2006/95) - 89/336 (2004/108) - 98/37 - 92/42 EEC			
According to	EN 267			
Certification	DIN 5G 975/01	DIN 5G 976/01	DIN 5G 977/01	DIN 5G 978/01

(01) Centrifugal with reverse curve blades

(02) Centrifugal with forward curve blades

(03) 1/50/230-(±10%)

(04) 3N/50/400-(±10%) 3/50/230-(±10%) Δ

(05) Intermittent (at least one stop every 24 h)

(06) Intermittent (at least one stop every 24 h) - Continuous as optional (at least one stop every 72 h)

Reference conditions:

Temperature: 20°C - Pressure: 1013,5 mbar - Altitude: 0 m a.s.l. - Noise measured at a distance of 1 meter.

FIRING RATES

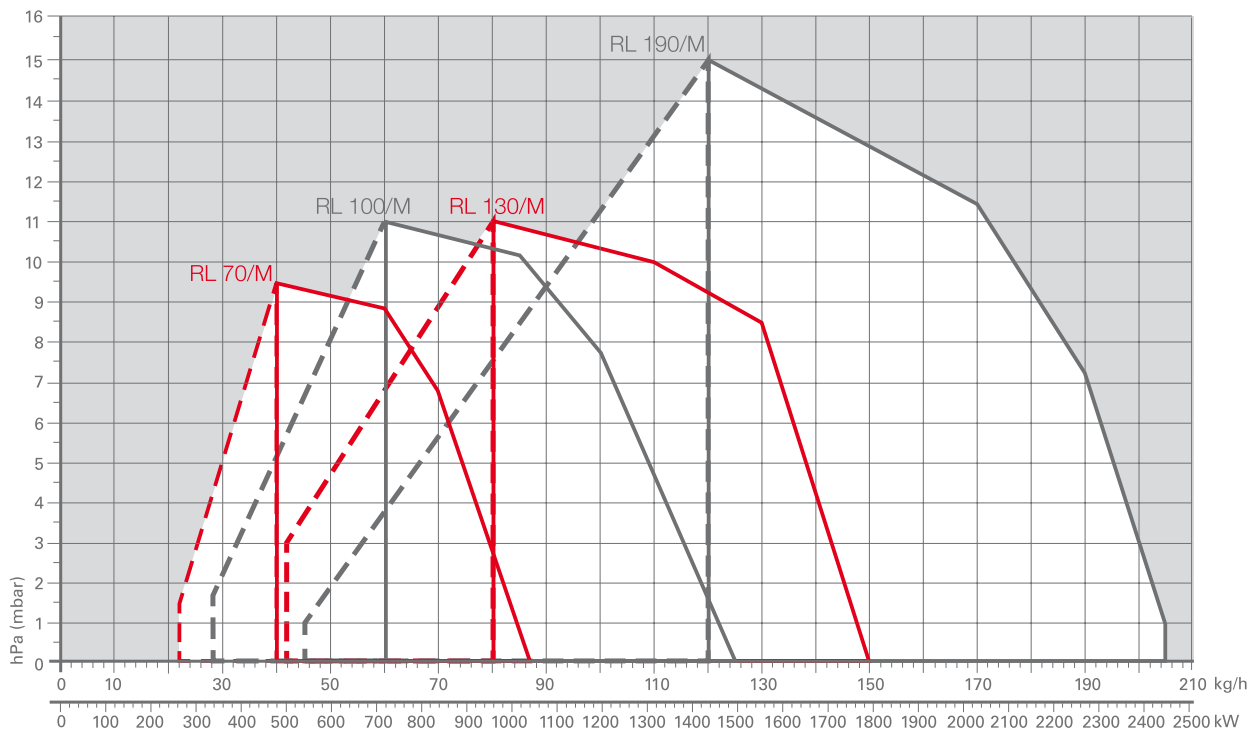
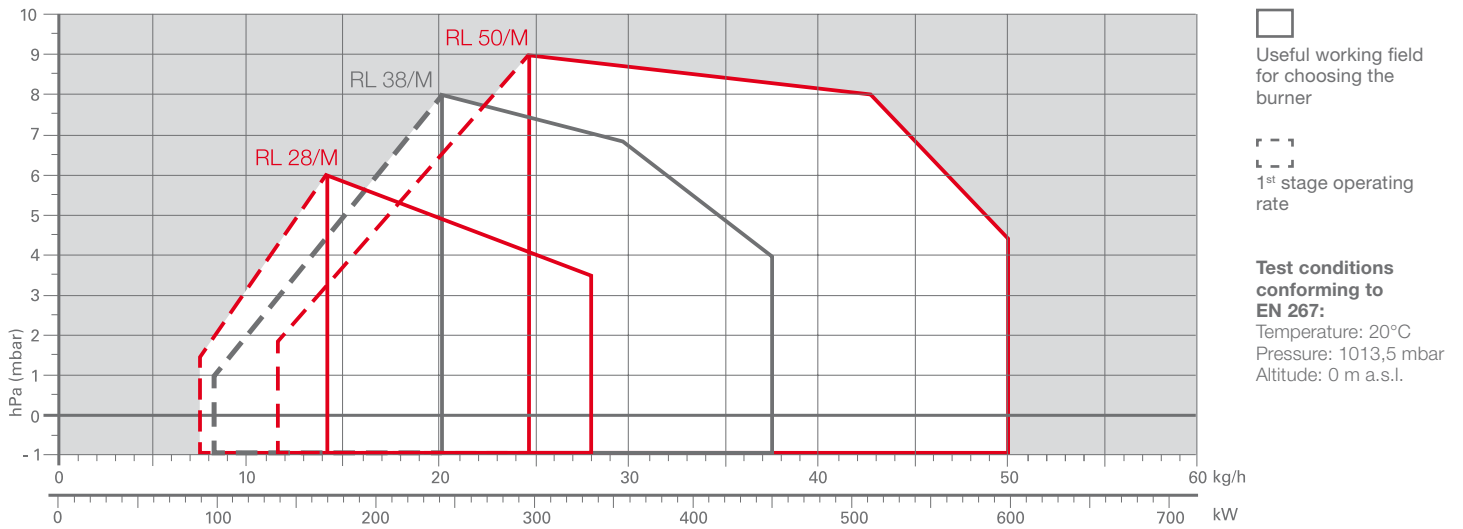

HYDRAULIC CIRCUITS

Various hydraulic circuits are available, depending on fuel output asset according to local norms of steam generators.

The burners are fitted with two valves for oil output from the pump: a pressure regulator on the return circuit from the nozzle allows varying the quantity of burnt fuel.

A safety valve on the return circuit impedes oil leakage from the nozzle when the burner is in stand by and pre-purge phases.

Beginning with the RL 100/M model, the burners have a double safety valve on the return circuit.

The models fitted with a minimum pressure switch on the oil delivery circuit can be installed on steam generators according to TRD-72 standard (Germany) and NBN standard (Belgium).



Example of the hydraulic circuit on RL70/M burners

EN 267 < 100 Kg/h

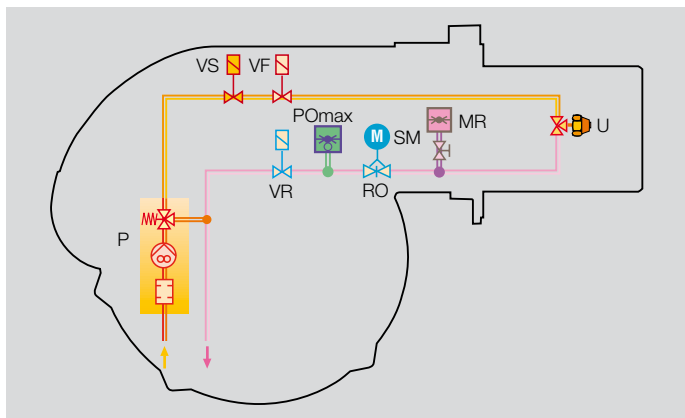

EN 267 > 100 Kg/h

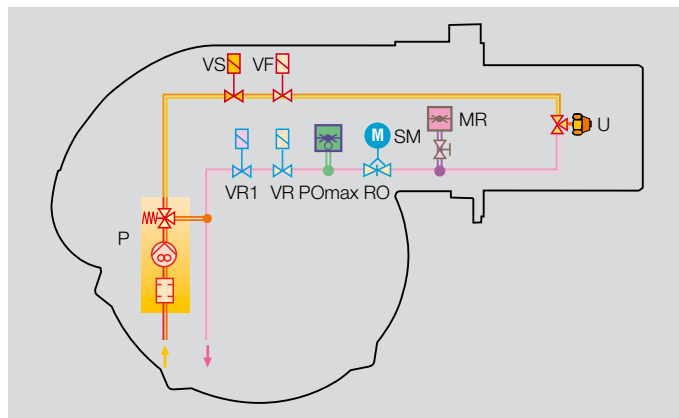

Versions for TRD-72, NBN steam generators

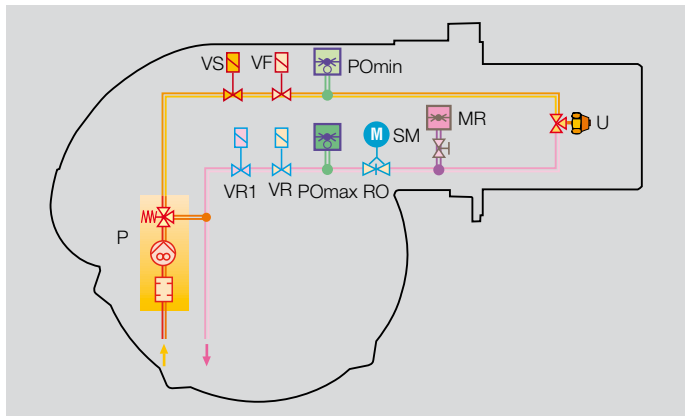

P	Pump with filter and pressure regulator on the output circuit
VS	Safety valve on the output circuit
VF	Working valve on the output circuit
PO min	Min. Oil pressure switch on the output circuit
U	Nozzle
MR	Pressure gauge on the return circuit
SM	Servomotor
RO	Pressure regulator on the return circuit
PO max	Max. Oil pressure switch on the return circuit
VR	1 st safety valve on the return circuit
VR1	2 nd safety valve on the return circuit

SELECTING THE FUEL SUPPLY LINES

The fuel feed must be completed with the safety devices required by the local norms.

The table shows the choice of piping diameter for the various burners, depending on the difference in height between the burner and the tank and their distance.

MAXIMUM EQUIVALENT LENGTH FOR THE PIPING L[m]

Model	RL 28/M			RL 38 - 50/M			RL 70 - 100 - 130/M			RL 190/M	
Diameter piping	Ø10 mm	Ø12 mm	Ø14 mm	Ø10 mm	Ø12 mm	Ø14 mm	Ø12 mm	Ø14 mm	Ø16 mm	Ø16 mm	Ø18 mm
+H, -H (m)	L max (m)	L max (m)	L max (m)	L max (m)	L max (m)	L max (m)	L max (m)	L max (m)	L max (m)	L max (m)	L max (m)
+4,0	83	144	150	51	112	150	71	138	150	60	80
+3,0	55	127	150	46	99	150	62	122	150	50	70
+2,0	48	111	150	39	86	150	58	106	150	40	60
+1,5	44	102	150	35	79	147	51	98	150	35	55
+1,0	40	94	150	32	73	144	44	90	150	30	50
+0,5	37	86	150	29	65	132	40	82	150	25	45
0	33	78	150	26	60	120	36	74	137	20	40
-0,5	29	70	133	23	54	106	32	66	123	18	35
-1,0	25	62	118	20	47	96	28	56	109	15	30
-1,5	21	53	103	16	40	83	23	49	95	13	25
-2,0	17	45	88	13	34	71	19	42	81	10	20
-3,0	10	29	58	7	21	46	10	26	53	5	10
-4,0	4	12	28	2	8	21	3	10	25	3	6

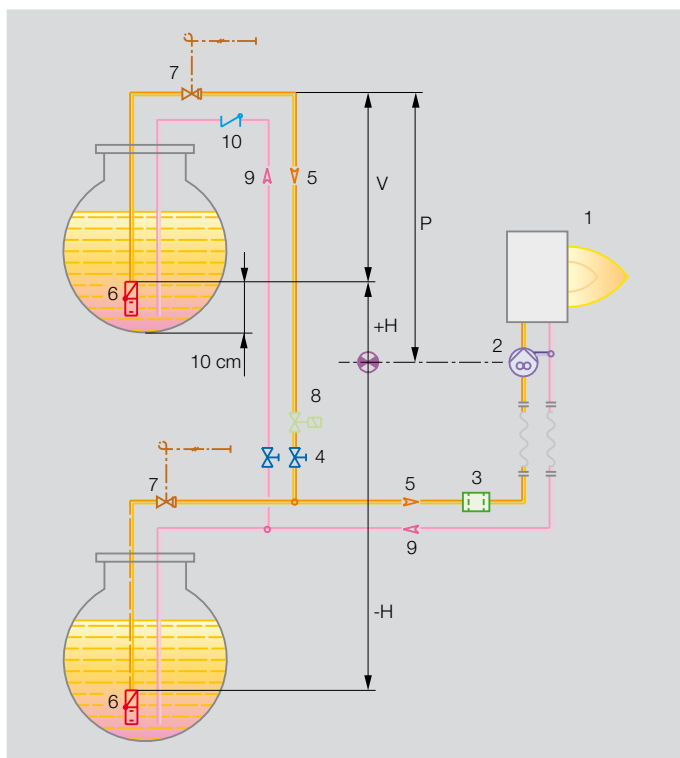

- H** Difference in height pump-foot valve
- Ø** Internal pipe diameter
- P** Height 10 m
- V** Height 4 m
- 1** Burner
- 2** Burner pump
- 3** Filter
- 4** Manual shut off valve
- 5** Suction pipework
- 6** Bottom valve
- 7** Remote controlled rapid manual shut off valve (compulsory in Italy)
- 8** Type approved shut off solenoid valve (compulsory in Italy)
- 9** Return pipework
- 10** Check valve

With ring distribution oil systems, the feasible drawings and dimensioning are the responsibility of specialised engineering studios, who must check compatibility with the requirements and features of each single installation.

Ventilation

The ventilation circuit produces low noise levels with high performance pressure and air output, in spite of the compact dimensions.

Except for the RL 190/M model, the use of reverse curve blades and sound proofing material keeps noise level very low.

In the RL 190/M model, sound has been reduced by the special design of the air suction circuit.

A variable profile cam connects fuel and air setting, ensuring high fuel efficiency in all firing ranges.



Example of the servomotor for air/oil setting

Combustion Head

Different lengths of the combustion head can be chosen for the RL series of burners.

The choice depends on the thickness of the front panel and the type of boiler.

Depending on the type of generator, check that the penetration of the head into the combustion chamber is correct.

The internal position of the combustion head can easily be adjusted to the maximum defined output by adjusting a screw fixed to the flange.



Example of a RL/M burner combustion head.

DIMENSIONS OF THE FLAME

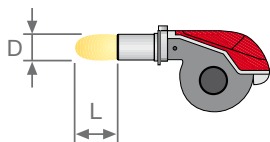

Example:
 Burner thermal output = 2000 kW;
 L_{flame} (m) = 2,7 m (medium value);
 D_{flame} (m) = 0,8 m (medium value)

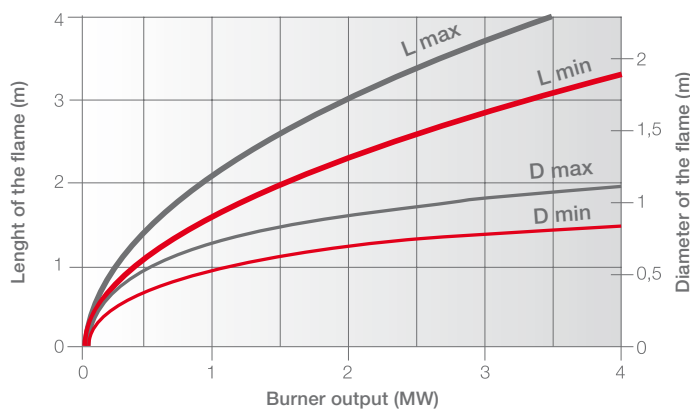



Operation

BURNER OPERATION MODE

The RL/M series of burners can have “two-stage progressive” or “modulating” operation.

On “two-stage progressive” operation, the burner gradually adapts the output to the requested level, by varying between two pre-set levels (see picture A).

On “modulating” operation, normally required in steam generators, in superheater boilers or diathermic oil burners, a specific regulator and probes are required. These are supplied as accessories that must be ordered separately. The burner can work for long periods at intermediate output levels (see picture B).

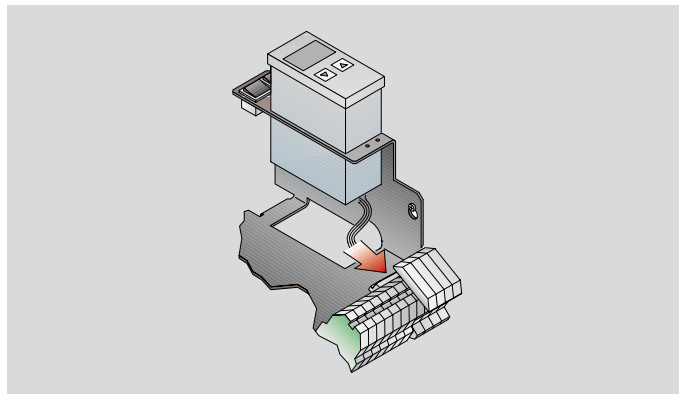

Example of a regulator.

“TWO-STAGE PROGRESSIVE” OPERATION

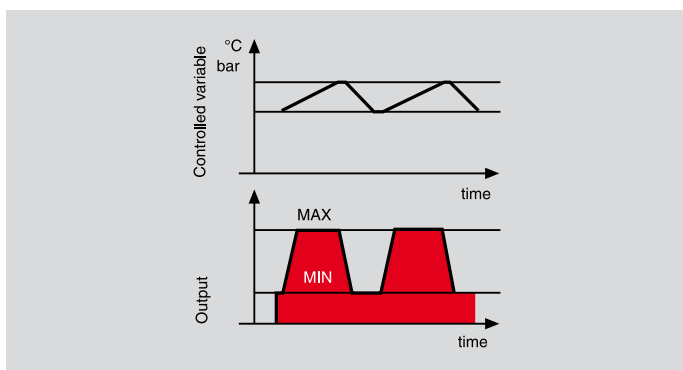

Picture A

“MODULATING” OPERATION

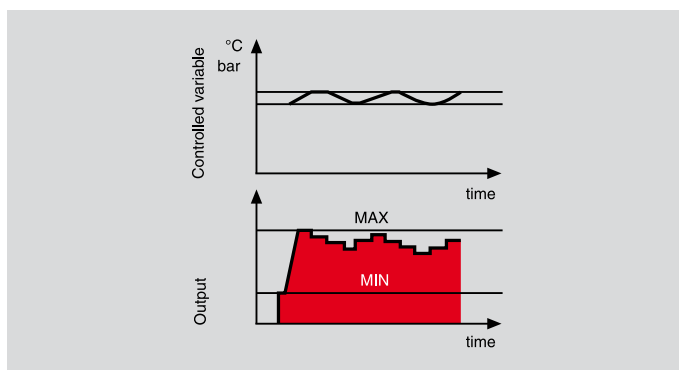

Picture B

START UP CYCLE

RL 28/M - 38/M - 50/M

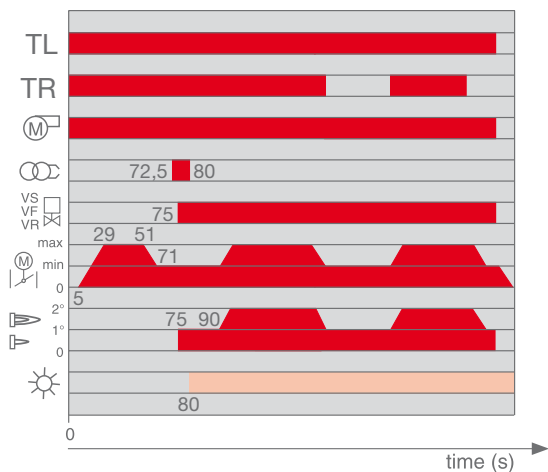

- 0 s The burner begins the firing cycle: the motor starts turning.
- 5-29 s The servomotor opens the air damper.
- 29-51 s Pre-purge with the air damper open.
- 51-71 s The servomotor takes the air damper to the firing position.
- 72.5 s Pre-ignition.
- 75 s Firing: all the oil solenoid valves are supplied.
- 90 s Output can be increased.

RL 70/M - 100/M - 130/M - 190/M

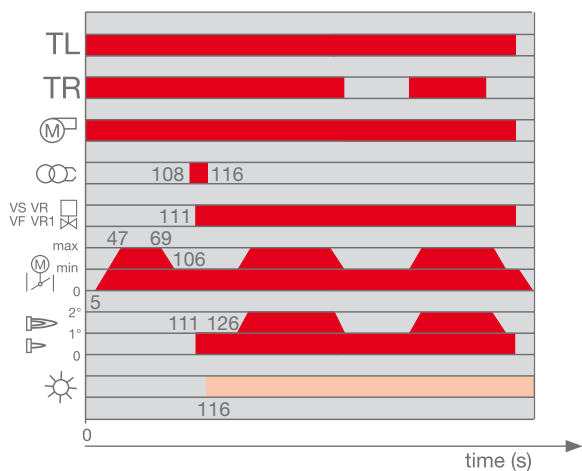

- 0 s The burner begins the firing cycle: the motor starts turning.
- 5-47 s The servomotor opens the air damper.
- 47-69 s Pre-purge with the air damper open.
- 69-106 s The servomotor takes the air damper to the firing position.
- 108 s Pre-ignition.
- 111 s Firing: all the oil solenoid valves are supplied.
- 126 s Output can be increased.

Burner Wiring

Electrical connections must be made by qualified and skilled personnel, according to the local norms.

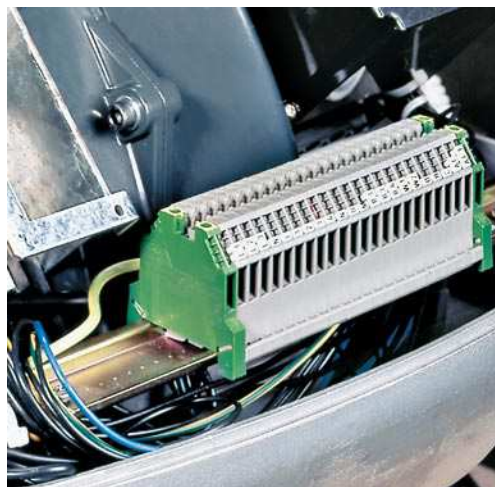

Example of the terminal board for electrical connections for the RL 70-100-130-190/M models.

“TWO-STAGE PROGRESSIVE” OPERATION

RL 28/M

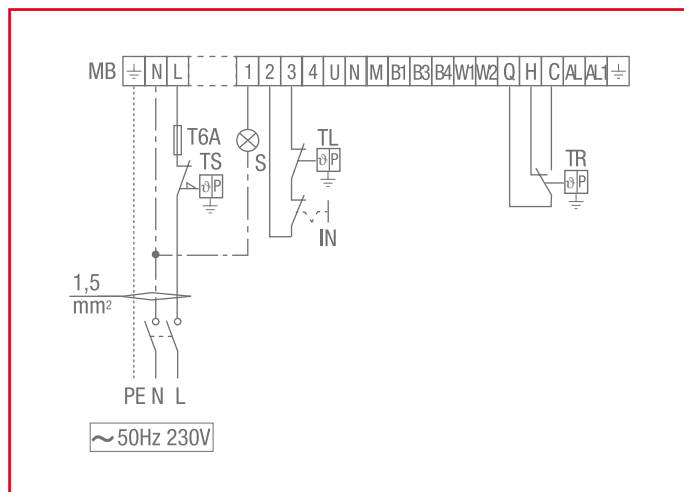

MB	Burner terminal board
TS	Safety thermostat
S	External lock-out signal
IN	Manual switch
TL	Threshold thermostat
TR	High/low flame setting thermostat
T6A	6A fuse

RL 38/M - 50/M - 70/M - 100/M - 130/M - 190/M

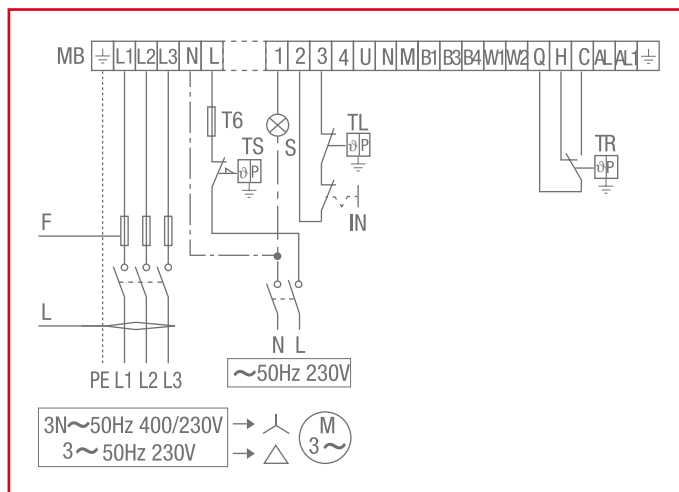

MB	Burner terminal board
TS	Safety thermostat
S	External lock-out signal
IN	Manual switch
TL	Threshold thermostat
TR	High/low flame setting thermostat
T6A	6A fuse
F	Fuse (see table A)
L	Lead section (see table A)

“MODULATING” OPERATION - TEMPERATURE PROBE

RL 28/M

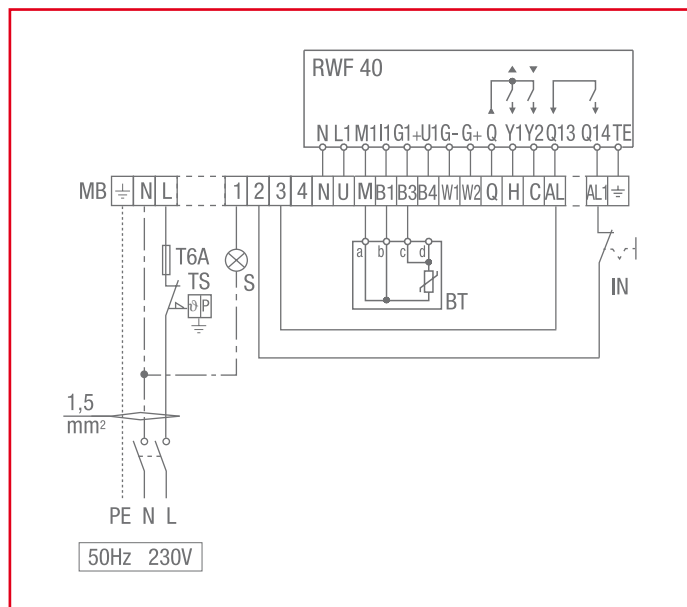

MB	Burner terminal board
TS	Safety thermostat
S	External lock-out signal
IN	Manual switch
BT	Temperature probe
T6A	6A fuse
RWF40	Regulator (fitted to the burner)

RL 38/M - 50/M - 70/M - 100/M - 130/M - 190/M

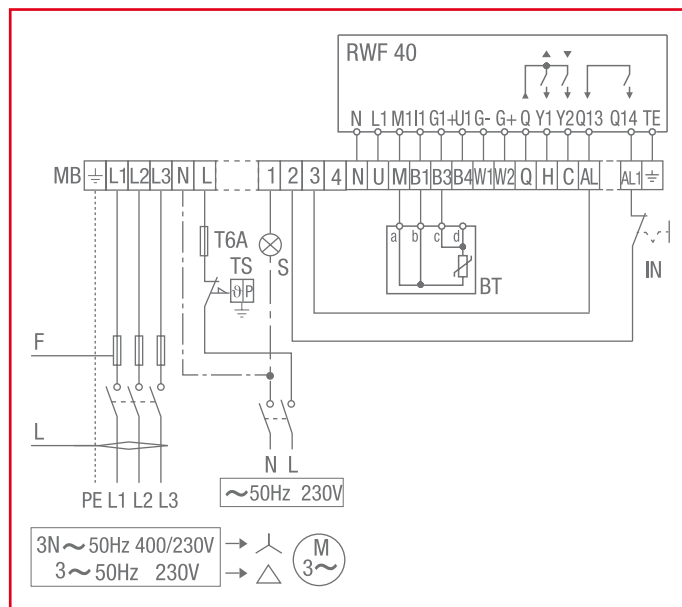

MB	Burner terminal board
TS	Safety thermostat
S	External lock-out signal
IN	Manual switch
BT	Temperature probe
T6A	6A fuse
F	Fuse (see table A)
L	Lead section (see table A)
RWF40	Regulator (fitted to the burner)

“MODULATING” OPERATION - PRESSURE PROBE

RL 28/M

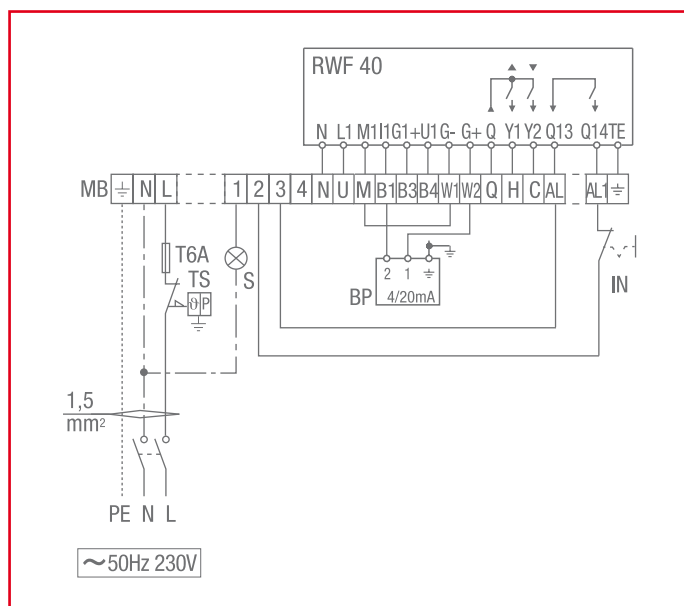

RL 38/M - 50/M - 70/M - 100/M - 130/M - 190/M

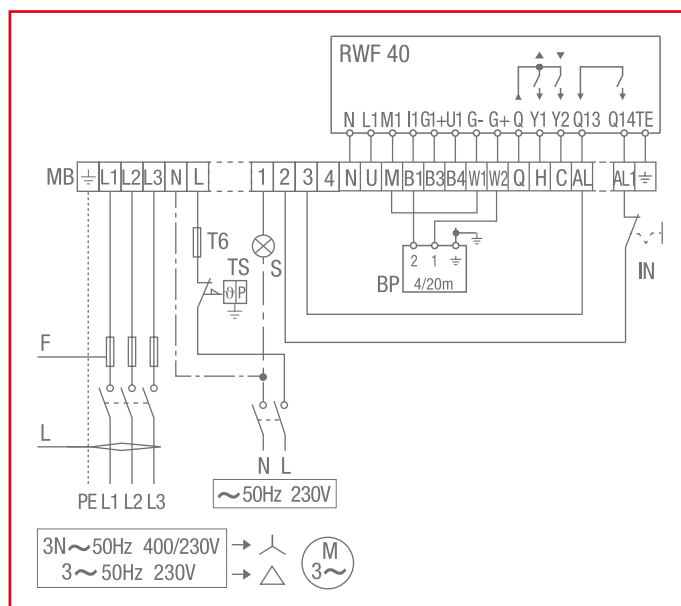

MB	Burner terminal board
TS	Safety thermostat
S	External lock-out signal
IN	Manual switch
BP	Pressure probe
T6A	6A fuse
RWF40	Regulator (installed to the burner)

MB	Burner terminal board
TS	Safety thermostat
S	External lock-out signal
IN	Manual switch
BP	Pressure probe
T6A	6A fuse
F	Fuse (see table A)
L	Lead section (see table A)
RWF40	Regulator (fitted to the burner)

The following table shows the supply lead sections and the type of fuse to be used.

MODEL	V	F (A)	L (mm ²)
▶ RL 28/M	230	T6	1,5
▶ RL 38/M	230	T6	1,5
	400	T6	1,5
▶ RL 50/M	230	T6	1,5
	400	T6	1,5
▶ RL 70/M	230	T10	1,5
	400	T6	1,5
▶ RL 100/M	230	T16	1,5
	400	T10	1,5

MODEL	V	F (A)	L (mm ²)
▶ RL 130/M	230	T16	1,5
	400	T10	1,5
▶ RL 190/M	230	T25	2,5
	400	T25	2,5

V = Electrical supply F = Fuse L = Lead section

The emission data has been measured in the various models at maximum output, according to EN 267 standard.

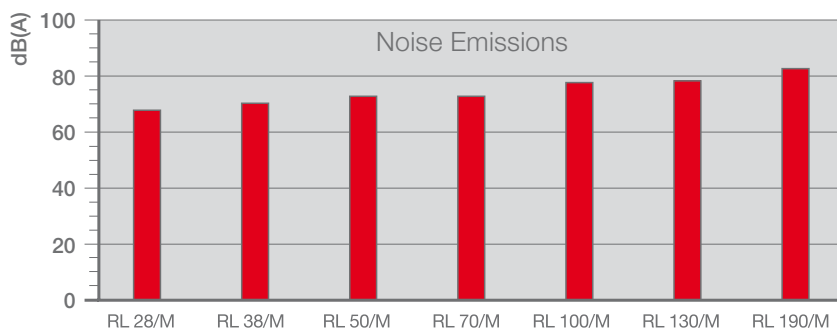
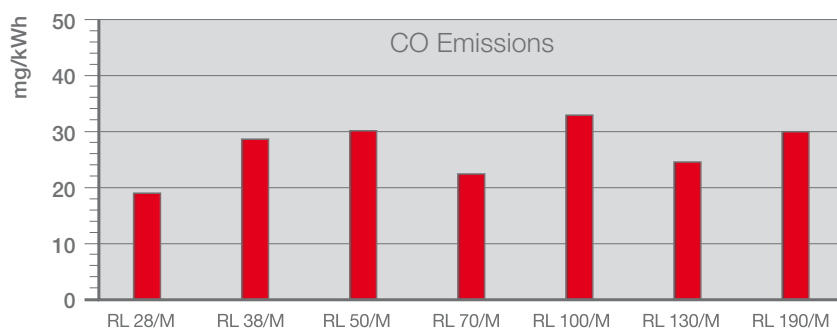
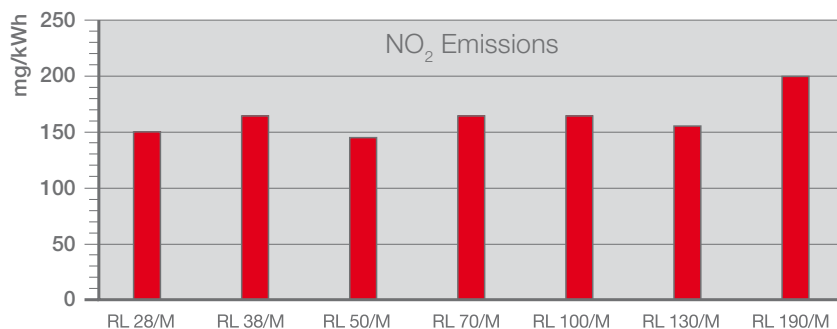

 **Overall Dimensions (mm)**

BURNERS

RL 28/M - 38/M - 50/M

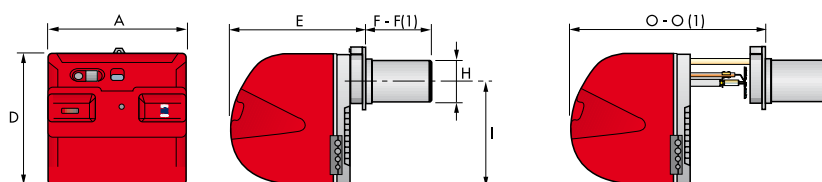

RL 70/M - 100/M - 130/M - 190/M

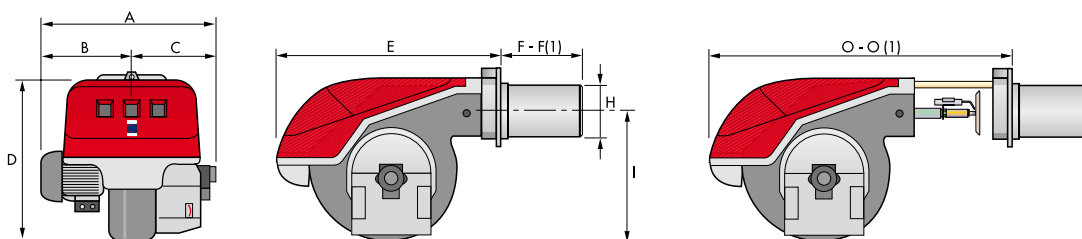

MODEL	A	B	C	D	E	F - F (1)	H	I	O - O (1)
▶ RL 28/M	476	-	-	474	468	241 - 351	140	352	672 - 807
▶ RL 38/M	476	-	-	474	468	241 - 351	140	352	672 - 807
▶ RL 50/M	476	-	-	474	468	241 - 351	152	352	672 - 807
▶ RL 70/M	663	296	367	555	680	272 - 385	179	430	951 - 1086
▶ RL 100/M	679	312	367	555	680	272 - 385	179	430	951 - 1086
▶ RL 130/M	705	338	367	555	680	272 - 385	189	430	951 - 1086
▶ RL 190/M	813	366	447	555	712	370	222	430	1166

(1) Length with extended combustion head.

BURNER - BOILER MOUNTING FLANGE

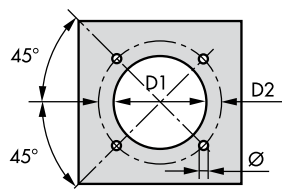

MODEL	D1	D2	Ø
▶ RL 28/M	160	224	M8
▶ RL 38/M	160	224	M8
▶ RL 50/M	160	224	M8
▶ RL 70/M	185	275 - 325	M12
▶ RL 100/M	185	275 - 325	M12
▶ RL 130/M	195	275 - 325	M12
▶ RL 190/M	230	325 - 368	M16

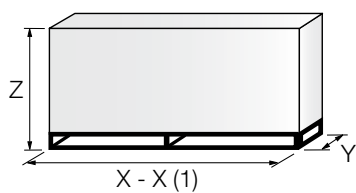

MODEL	X - X (1)	Y	Z	kg
▶ RL 28/M	872	540	550	39
▶ RL 38/M	872	540	550	41
▶ RL 50/M	872	540	550	42
▶ RL 70/M	1150	792	600	65
▶ RL 100/M	1150	792	600	68
▶ RL 130/M	1150	792	600	71
▶ RL 190/M	1200	800	850	95

(1) Length with extended combustion head.

Installation Description

Installation, start up and maintenance must be carried out by qualified and skilled personnel.
All operations must be performed in accordance with the technical handbook supplied with the burner.

BURNER SETTING

All the burners have slide bars, for easier installation and maintenance.

After drilling the boilerplate, using the supplied gasket as a template, dismantle the blast tube from the burner and fix it to the boiler.

Adjust the combustion head.

Refit the burner casing to the slide bars.

Install the nozzle, choosing this on the basis of the maximum boiler output and following the diagrams included in the burner instruction handbook.

Check the position of the electrodes.

Close the burner, sliding it up to the flange, keeping it slightly raised to avoid the flame stability disk rubbing against the blast tube.



HYDRAULIC AND ELECTRICAL CONNECTIONS AND START UP

The burners are supplied for connection to two pipes fuel supply system.

Connect the ends of the flexible pipes to the suction and return pipework using the supplied nipples.

Make the electrical connections to the burner following the wiring diagrams included in the instruction handbook.

Prime the pump by turning the motor (after checking rotation direction if it is a three phase motor).

On start up, check:

- Pressure pump and valve unit regulator (to max. and min.)
- Combustion quality, in terms of unburned substances and excess air.





Return nozzles type A3 45°

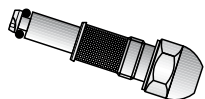

The following list shows the features and codes on the basis of the maximum required fuel output.

NOTE: each burner needs N° 1 nozzle.

BURNER	RATED OUTPUT kg/h	NOZZLE CODE
▶ RL 28/M	15	3009850
▶ RL 28/M - 38/M	20	3009851
▶ RL 28/M - 38/M - 50/M	30	3009852
▶ RL 38/M - 50/M - 70/M	40	3009853
▶ RL 50/M - 70/M	50	3009854
▶ RL 70/M - 100/M	60	3009855
▶ RL 70/M - 100/M	70	3009856
▶ RL 100/M - 130/M	80	3009857
▶ RL 100/M - 130/M	90	3009858
▶ RL 100/M - 130/M	100	3009859
▶ RL 130/M	110	3009860
▶ RL 130/M - 190/M	120	3009861
▶ RL 130/M - 190/M	130	3009862
▶ RL 190/M	140	3009863
▶ RL 190/M	160	3009864
▶ RL 190/M	180	3009865
▶ RL 190/M	200	3009866

Extended head kit

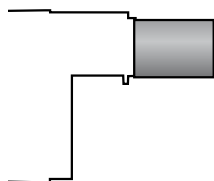

“Standard head” burners can be transformed into “extended head” versions, by using the special kit.

BURNER	STANDARD HEAD LENGTH (mm)	EXTENDED HEAD LENGTH (mm)	KIT CODE
▶ RL 28/M	241	351	3010120
▶ RL 38/M	241	351	3010121
▶ RL 50/M	241	351	3010122
▶ RL 70/M	272	385	3010159
▶ RL 100/M	272	385	3010160
▶ RL 130/M	272	385	3010161
▶ RL 190/M	370	-	-

Spacer kit



If burner head penetration into the combustion chamber needs reducing, varying thickness spacers are available, as given in the following list.

BURNER	SPACER THICKNESS S (mm)	KIT CODE
▶ RL 28/M - 38/M - 50/M	90	3010095
▶ RL 70/M - 100/M - 130/M	135	3010129
▶ RL 190/M	102	3000722

Sound proofing box



If noise emission needs reducing even further, sound-proofing boxes are available.

BURNER	BOX TYPE	AVERAGE NOISE REDUCTION [dB(A)] (*)	BOX CODE
▶ RL 28/M - 38/M - 50/M	C1/3	10	3010403
▶ RL 70/M - 100/M - 130/M - 190/M	C4/5	10	3010404

(*) according to EN 15036-1 standard

Degasing unit



To solve problem of air in the oil sucked, two versions of degasing unit are available.

BURNER	FILTER	FILTERING DEGREE (µm)	DEGASING UNIT CODE
▶ RL 28/M - 38/M - 50/M - 70/M - 100/M	With filter	50 - 75	3010055
▶ RL 28/M - 38/M - 50/M - 70/M - 100/M	Without filter	-	3010054

Head kit for “reverse flame chamber”



In certain cases, the use of the burner on reverse flame boilers can be improved by using an additional cylinder.

BURNER	STANDARD HEAD LENGTH WITH CYLINDER (mm)	EXTENDED HEAD LENGTH WITH CYLINDER (mm)	KIT CODE
▶ RL 28/M - 38/M	319	429	3010178
▶ RL 50/M	319	429	3010179
▶ RL 70/M - 100/M	375	488	3010180
▶ RL 130/M	375	488	3010183
▶ RL 190/M	493	-	3010241

Connection flange kit

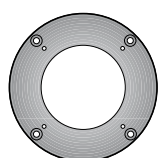

A kit is available for use where the burner opening on the boiler is of excessive diameter.

BURNER	KIT CODE
▶ RL 28/M - 38/M - 50/M	3010138

Accessories for modulating operation



To obtain modulating operation, the RL/M series of burners requires a regulator.

BURNER	REGULATOR TYPE	REGULATOR CODE
▶ RL 28/M - 38/M - 50/M RL 70/M - 100/M - 130/M - 190/M	RWF 40	3010212



The relative temperature or pressure probes fitted to the regulator, must be chosen on the basis of the application.

BURNER	PROBE TYPE	RANGE (°C) (bar)	PROBE CODE
▶ RL 28/M - 38/M - 50/M RL 70/M - 100/M - 130/M - 190/M	Temperature PT 100	-100 ÷ 500°C	3010110
	Pressure 4 ÷ 20 mA	0 ÷ 2,5 bar	3010213
	Pressure 4 ÷ 20 mA	0 ÷ 16 bar	3010214



Depending on the servomotor fitted to the burner, a three-pole potentiometer (1000 Ω) can be installed to check the position of the servomotor.

BURNER	POTENTIOMETER KIT CODE
▶ RL 28/M - 38/M - 50/M	3010109
▶ RL 70/M - 100/M - 130/M - 190/M	3010021

Specification

DESIGNATION OF SERIES

A specific index guides your choice of burner from the various models available in the RL series. Below is a clear and detailed specification description of the product.

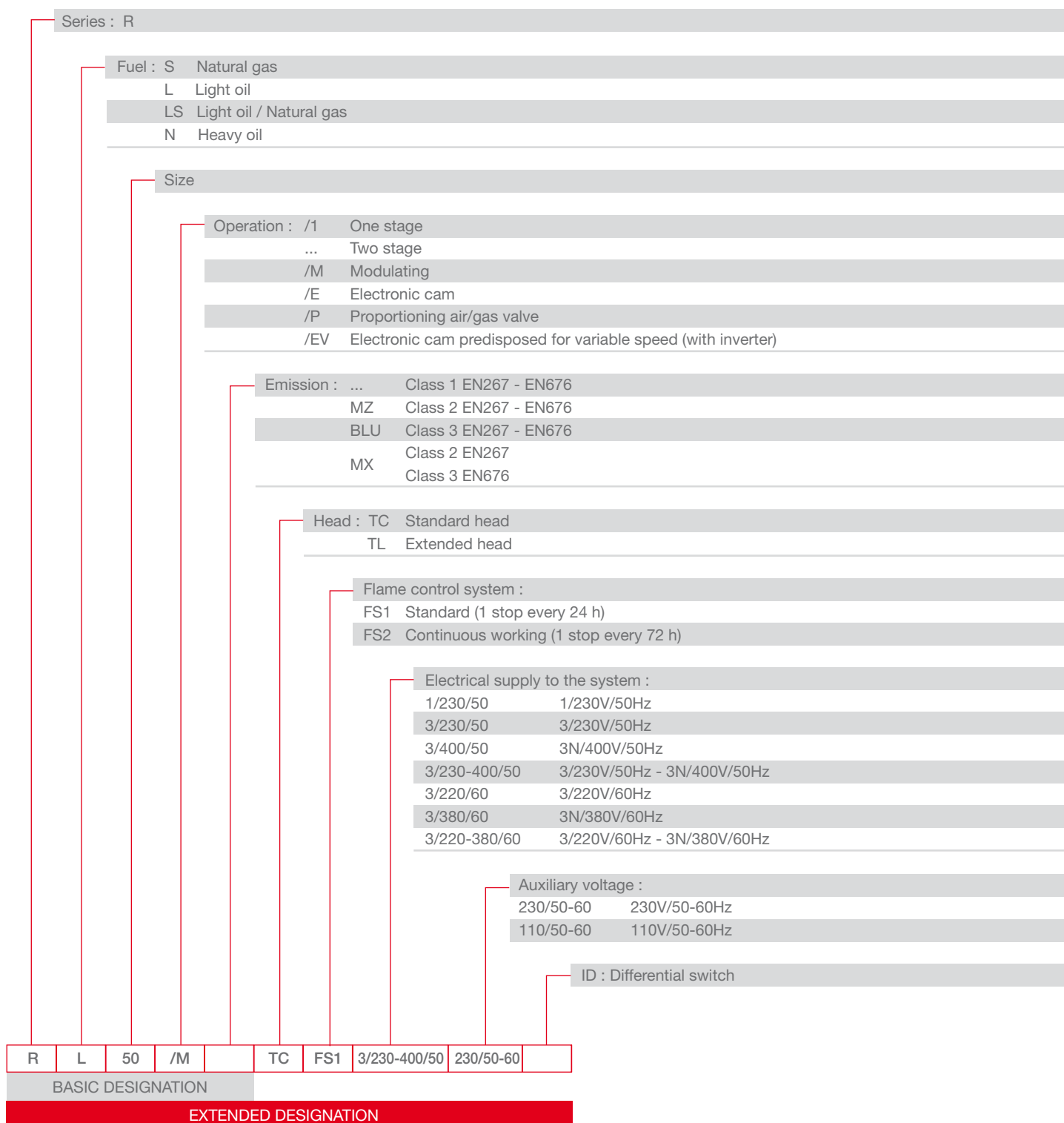

AVAILABLE BURNER MODELS

RL 28/M	TC	FS1	1/230/50	230/50-60
RL 28/M	TL	FS1	1/230/50	230/50-60
RL 28/M	TC	FS1	1/220-230/60	230/50-60
RL 28/M	TL	FS1	1/220-230/60	230/50-60
RL 38/M	TC	FS1	3/230-400/50	230/50-60
RL 38/M	TL	FS1	3/230-400/50	230/50-60
RL 38/M	TC	FS1	3/208-230/380-460/60	230/50-60
RL 38/M	TL	FS1	3/208-230/380-460/60	230/50-60
RL 50/M	TC	FS1	3/230-400/50	230/50-60
RL 50/M	TL	FS1	3/230-400/50	230/50-60
RL 50/M	TC	FS1	3/208-230/380-460/60	230/50-60
RL 50/M	TL	FS1	3/208-230/380-460/60	230/50-60
RL 70/M	TC	FS1	3/230-400/50	230/50-60
RL 70/M	TL	FS1	3/230-400/50	230/50-60
RL 70/M	TC	FS1	3/208-230/380-460/60	230/50-60
RL 70/M	TL	FS1	3/208-230/380-460/60	230/50-60
RL 70/M	TC	FS2	3/230-400/50	230/50-60
RL 70/M	TL	FS2	3/230-400/50	230/50-60
RL 100/M	TC	FS1	3/230-400/50	230/50-60
RL 100/M	TL	FS1	3/230-400/50	230/50-60
RL 100/M	TC	FS1	3/208-230/380-460/60	230/50-60
RL 100/M	TL	FS1	3/208-230/380-460/60	230/50-60
RL 100/M	TC	FS2	3/230-400/50	230/50-60
RL 100/M	TL	FS2	3/230-400/50	230/50-60
RL 130/M	TC	FS1	3/230-400/50	230/50-60
RL 130/M	TL	FS1	3/230-400/50	230/50-60
RL 130/M	TC	FS1	3/208-230/380-460/60	230/50-60
RL 130/M	TL	FS1	3/208-230/380-460/60	230/50-60
RL 130/M	TC	FS2	3/230-400/50	230/50-60
RL 130/M	TL	FS2	3/230-400/50	230/50-60
RL 190/M	TC	FS1	3/230-400/50	230/50-60
RL 190/M	TC	FS1	3/208-230/380-460/60	230/50-60
RL 190/M	TC	FS2	3/230-400/50	230/50-60

Other versions are available on request.

PRODUCT SPECIFICATION

Burner

Monoblock forced draught oil burner with two stage progressive or modulating setting, with a specific kit, fully automatic, made up of:

- air suction circuit lined with sound-proofing material
- fan with reverse curve blades (forward curve blades on the 190/M model) high performance with low sound emissions
- air damper for air setting and automatic oil output regulator controlled by a servomotor with variable cam
- starting motor at 2800 rpm, three-phase 400V with neutral, 50Hz (single-phase, 230V and 50Hz for the 28/M model)
- combustion head, that can be set on the basis of required output, fitted with:
 - stainless steel end cone, resistant to corrosion and high temperatures
 - ignition electrodes
 - flame stability disk
- gears pump for high pressure fuel supply, fitted with:
 - filter
 - pressure regulator
 - connections for installing a pressure gauge and vacuumeter
 - internal by-pass for single pipe installation
- valve unit with a double oil safety valve on the output circuit and safety valve on the return circuit; double safety valve on the return circuit for models RL 100/M, RL 130/M, RL 190/M and for all models in the TRD-72, NBN version
- safety oil pressure switch for stop the burner in case of problems in the return circuit
- minimum oil pressure switch in the output circuit for the TRD-72, NBN versions
- photocell for flame detection
- flame control panel, fitted with control function for the correct positioning of the servomotor and possibility of post-ventilation by just changing the electric wiring
- burner on/off switch
- flame inspection window
- manual or automatic output increase/decrease switch
- slide bars for easier installation and maintenance
- protection filter against radio interference
- IP 44 electric protection level.

Conforming to:

- 89/336 (2004/108) EC directive (electromagnetic compatibility)
- 73/23 (2006/95) EC directive (low voltage)
- 92/42/EC directive (performance)
- 98/37/EC directive (machinery)
- EN 267 (liquid fuel burners).

Standard equipment:

- 2 flexible pipes for connection to the oil supply network
- 2 gaskets for the flexible pipes
- 2 nipples for connection to the pump
- 4 screws for fixing the burner flange to the boiler
- 1 thermal screen
- wiring loom fittings for electrical connections
- 2 slide bar extensions (for the extended head models and the RL 190/M model)
- instruction handbook for installation, use and maintenance
- spare parts catalogue.

Available accessories to be ordered separately:

- return nozzles
- extended head kit (except for the RL 190/M model)
- spacer kit
- sound-proofing box
- degasing unit
- head kit for "reverse flame chamber"
- connection flange kit
- RWF 40 output regulator
- temperature probe -100 – 500°C
- pressure probe 0 – 2.4 bar
- pressure probe 0 – 16 bar
- potentiometer kit for the servomotor.

RIELLO s.p.A.

Via Ing. Pilade Riello, 5
37045 Legnago (VR) Italy
Tel. +39.0442.630111 - Fax +39.0442.21980
www.rielloburners.com - info@rielloburners.com

Since the Company is constantly engaged in the production improvement, the aesthetic and dimensional features, the technical data, the equipment and the accessories can be changed.
This document contains confidential and proprietary information of RIELLO S.p.A. Unless authorised, this information shall not be divulged, nor duplicated in whole or in part.



Riello Burners is a brand of Riello Group.