

MODULATING GAS BURNERS

▶ GAS P/M SERIES	▶ GAS	3 P/M	80/130 ÷ 350 kW
	▶ GAS	4 P/M	120/180 ÷ 470 kW
	▶ GAS	5 P/M	155/320 ÷ 660 kW
	▶ GAS	6 P/M	300/520 ÷ 1050 kW
	▶ GAS	7 P/M	400/800 ÷ 1760 kW
	▶ GAS	8 P/M	640/1162 ÷ 2210 kW
	▶ GAS	9 P/M	870/1744 ÷ 3488 kW
	▶ GAS	10 P/M	1140/2441 ÷ 4885 kW

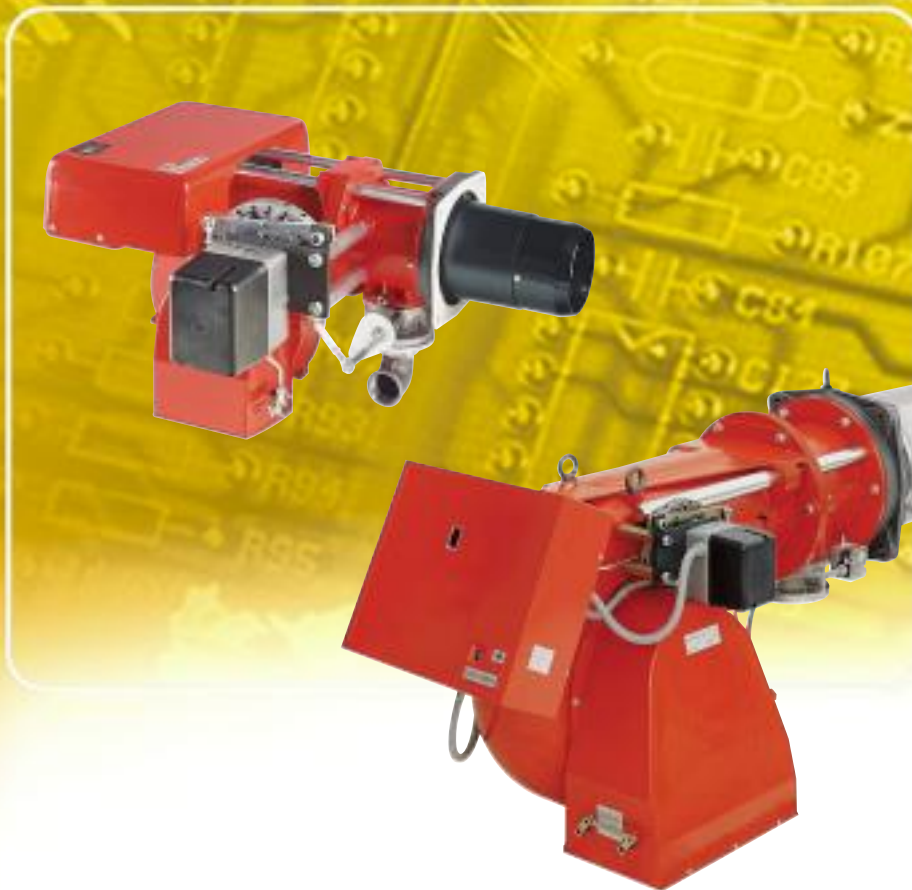

The GAS P/M series cover a firing range from 80 to 4885 kW. Operation is featured by progressive two stage operation or full modulation, with an advanced modulating control system and probes. The burners of GAS P/M series are well suited for applications requiring versatility of control (process, steam, refrigerating absorption) where a variable output is needed. Due to their metal sheet structures, they are specifically suitable for process applications where plastic materials could be easily damaged or deformed. Simplified maintenance is achieved by sliding bars which permit the access to the combustion head without need of removing the burner from the boiler.

TECHNICAL DATA

Model		▼ GAS 3 P/M	▼ GAS 4 P/M	▼ GAS 5 P/M	▼ GAS 6 P/M	▼ GAS 7 P/M	▼ GAS 8 P/M	▼ GAS 9 P/M	▼ GAS 10 P/M	
Burner operation mode		Modulating (with regulator and probes accessories) or Two stage progressive								
Modulation ratio at max. output		4 ÷ 1								
Servo-motor	Type	SQM 10								
	Run time	s 42								
Heat output	kW	80/130÷350	120/180÷470	155/320÷660	300/520÷1050	400/800÷1760	640/1162÷2210	870/1744÷3488	1140/2441÷4885	
	Mcal/h	69/112÷301	104/155÷404	133/275÷568	258/447÷903	344/688÷1514	550/1000÷1900	750/1500÷3000	980/2100÷4200	
Working temperature		°C min./max. 0/40								
Net calorific value G20 gas		kWh/Nm ³ 10								
G20 gas density		kg/Nm ³ 0,71								
G20 gas delivery		Nm ³ /h	8/13÷35	12/18÷47	15,5/32÷66	30/52÷105	40/80÷176	64/116,3÷221	87/174,4÷348,8	114/244,1÷488,5
Net calorific value G25 gas		kWh/Nm ³ 8,6								
G25 gas density		kg/Nm ³ 0,78								
G25 gas delivery		Nm ³ /h	9,3/15,1÷40,7	13,9/20,9÷54,6	18/37,2÷76,7	34,8/60,4÷122	46,5/92,9÷204,4	74,3/135÷256,7	101,1/202,6÷405,1	132,4/283,5÷567,4
Net calorific value LPG gas		kWh/Nm ³ 29,2								
LPG gas density		kg/Nm ³ 2,16								
LPG gas delivery		Nm ³ /h	2,7/4,5÷12	4,1/6,2÷16,1	5,3/11÷22,6	10,3/17,8÷36	13,7/27,4÷60,3	21,9/39,9÷75,8	29,8/59,8÷119,6	39,1/83,7÷167,5
Fan		type Centrifugal with forward curve blades								
Air temperature		max. °C 60								
Electrical supply		Ph/Hz/V	1/50/230 (±10%)			3N/50/400-230 (±10%)				
Auxiliary electrical supply		Ph/Hz/V	1/50/230 (±10%)							
Control box		type	LANDIS LFL 1.333							
Total electrical power		kW	0,4	0,54	0,85	1,7	3,4	5	9	14
Auxiliary electrical power		kW	0,15	0,17	0,1	0,2	0,4	1	1,5	2
Protection level		IP	40				55			
Motor electrical power		kW	0,25	0,37	0,75	1,5	3	4	7,5	12
Rated motor current		A	1,8	2,9	2,85 - 1,65	5,9 - 3,4	8 - 13,5	9,5 - 16,4	17,5 - 30	26 - 45
Motor start up current		A	4,8	9,5	10 - 6	22,5 - 13	51 - 86	48 - 83	113 - 195	151 - 261
Motor protection level		IP	44				55			
Ignition transformer		type	--							
		V1 - V2	230V - 1x8 kV							
		I1 - I2	1,8A - 30 mA							
Operation		Intermittent (at least one stop every 24 h) - Continuous (at least one stop every 72 h)								
Sound pressure		dB(A)	74,6	78	83,8	83,7	84,8	85,9	89,4	90
Sound output		W	--							
CO emission		mg/kWh	< 60							
NOx emission		mg/kWh	< 120							
Directive		90/396 - 89/336 - 73/23 - 92/42 EEC								
Conforming to		EN 676								
Certification		CE 0085AQ0710				CE 0085AP0941		CE 0085AP0942		CE 0085AP0943

Reference conditions:
 Temperature: 20°C
 Pressure: 1013,5 mbar
 Altitude: 100 m a.s.l.
 Noise measured at a distance of 1 meter.

Since the Company is constantly engaged in the production improvement, the aesthetic and dimensional features, the technical data, the equipment and the accessories can be changed.
 This document contains confidential and proprietary information of RIELLO S.p.A. Unless authorised, this information shall not be divulged, nor duplicated in whole or in part.



FIRING RATES

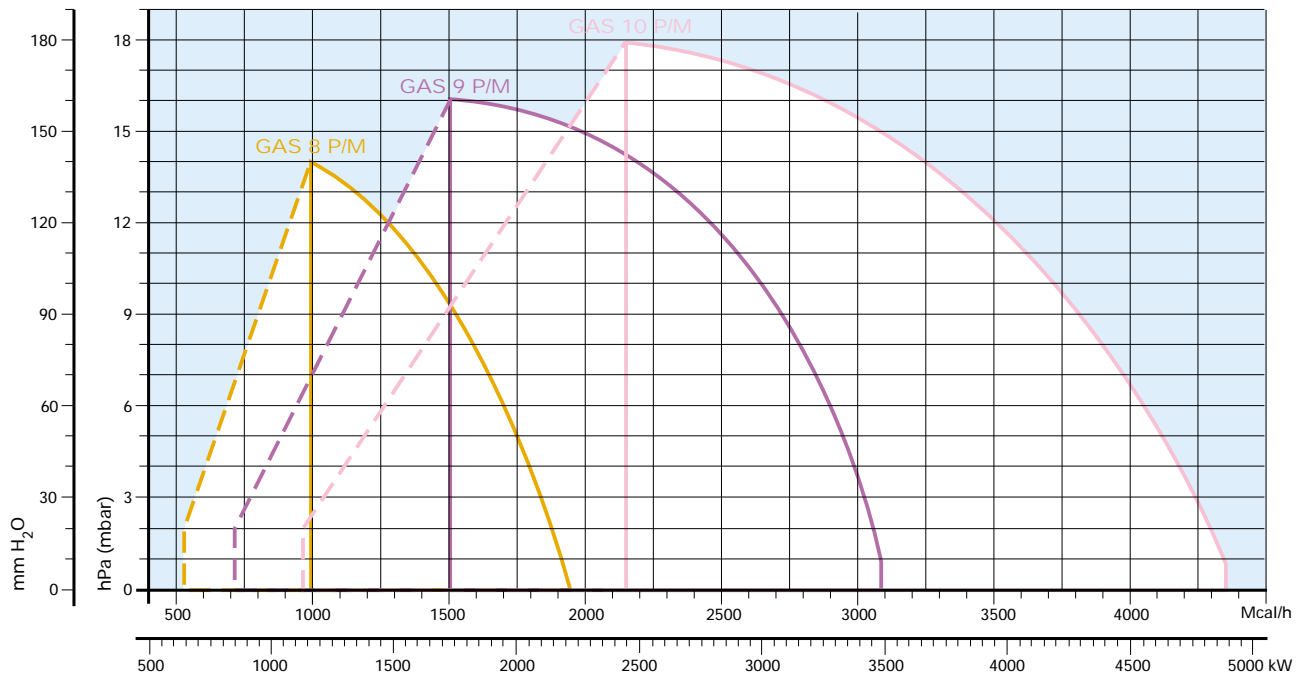
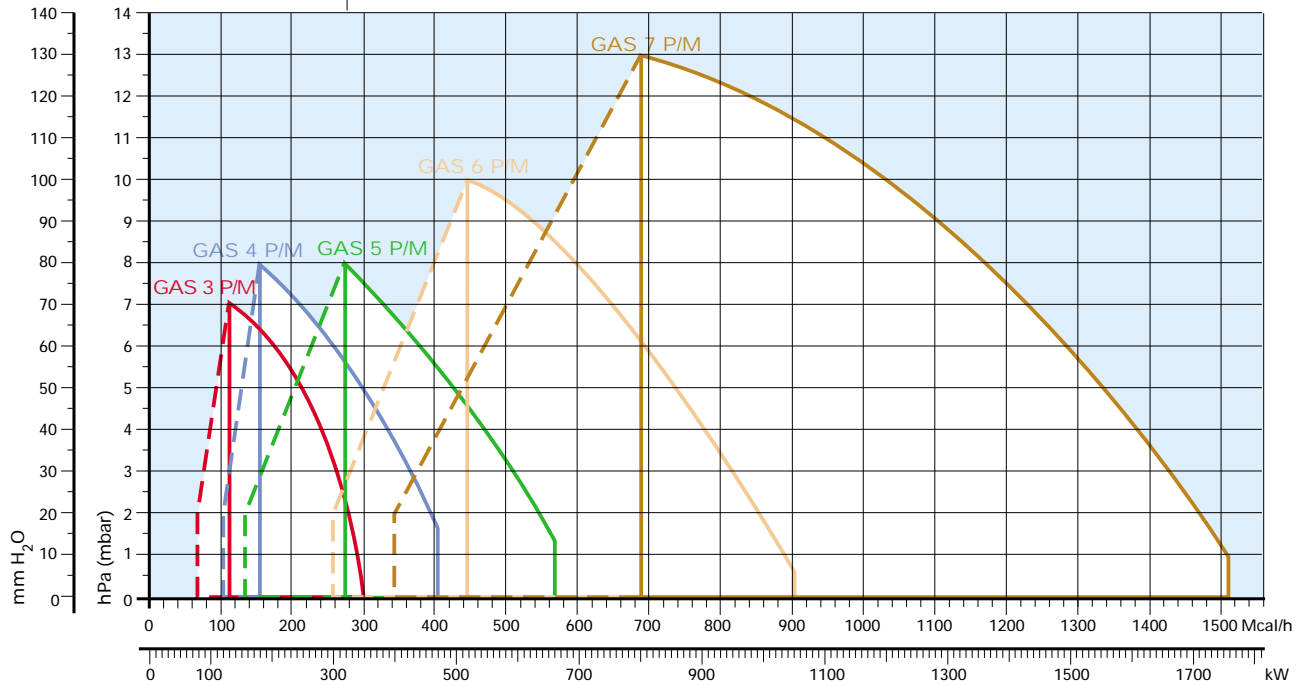

 Useful working field for choosing the burner

 Modulation range

Test conditions conforming to EN 676:

Temperature: 20°C

Pressure: 1013.5 mbar

Altitude: 100 m a.s.l.



FUEL SUPPLY

▶ GAS TRAIN

The burners are fitted with a butterfly valve to regulate the fuel, controlled by a variable profile cam servomotor.

Fuel can be supplied either from the right or left hand sides, on the basis of the application requirements. A maximum gas pressure switch stops the burner in case of an excess of pressure in fuel line.

The gas train can be selected to best fit system requirements depending on the fuel output and pressure in the supply line. The gas train can be "Multibloc" type (containing the main components in a single unit) or "Composed" type (assembly of the single components).



Example of the variable profile cam on GAS 3-4-5-6-7 P/M burners.

MULTIBLOC gas train without seal control

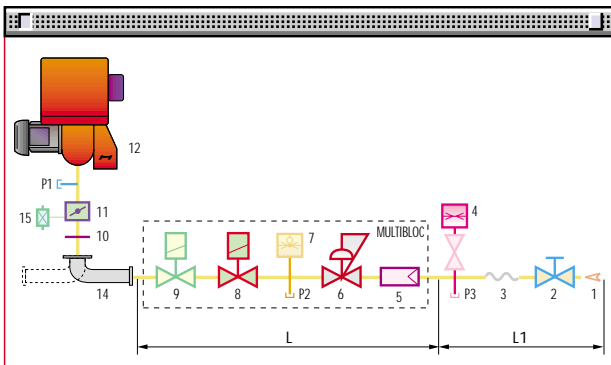

1	Gas input pipework
2	Manual valve
3	Anti-vibration joint
4	Pressure gauge with pushbutton cock.
5	Filter
6	Pressure regulator (vertical)
7	Minimum gas pressure switch
8	VS safety solenoid (vertical)
9	VR regulation solenoid (vertical) Two settings: - firing output (rapid opening) - maximum output (slow opening)
10	Gasket and flange supplied with the burner
11	Gas adjustment butterfly valve
12	Burner
13	Seal control mechanism for valves 8-9. According to standard EN 676, the seal control is compulsory for burners with maximum output above 1200 kW.
14	Gas train-burner adapter.
15	Maximum gas pressure switch
P1	Combustion head pressure
P2	Pressure downstream from the regulator
P3	Pressure upstream from the filter
L	Gas train supplied separately, with the code given in the table
L1	Installer's responsibility

MULTIBLOC gas train with seal control

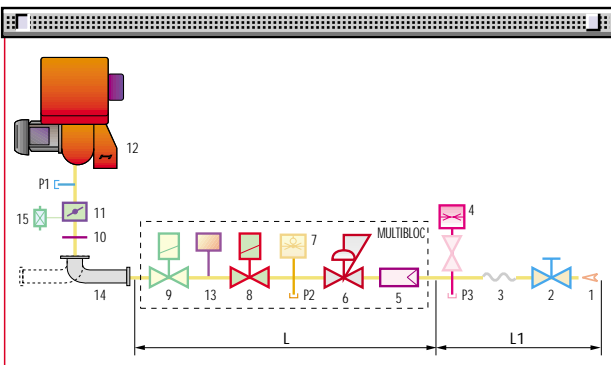

COMPOSED gas train without seal control

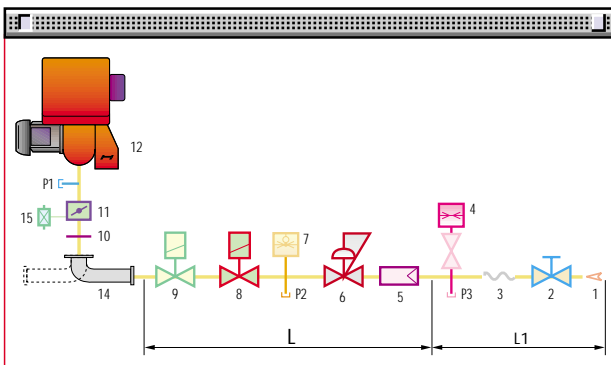

COMPOSED gas train with seal control

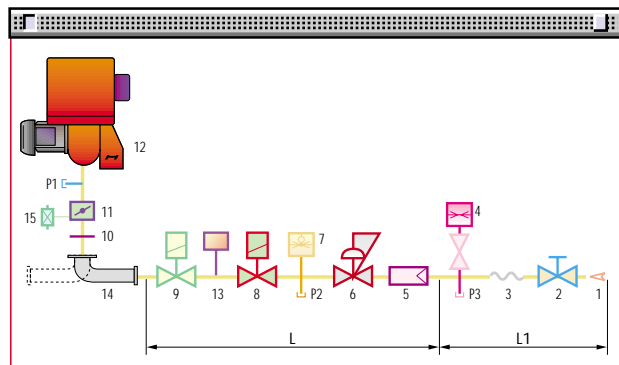

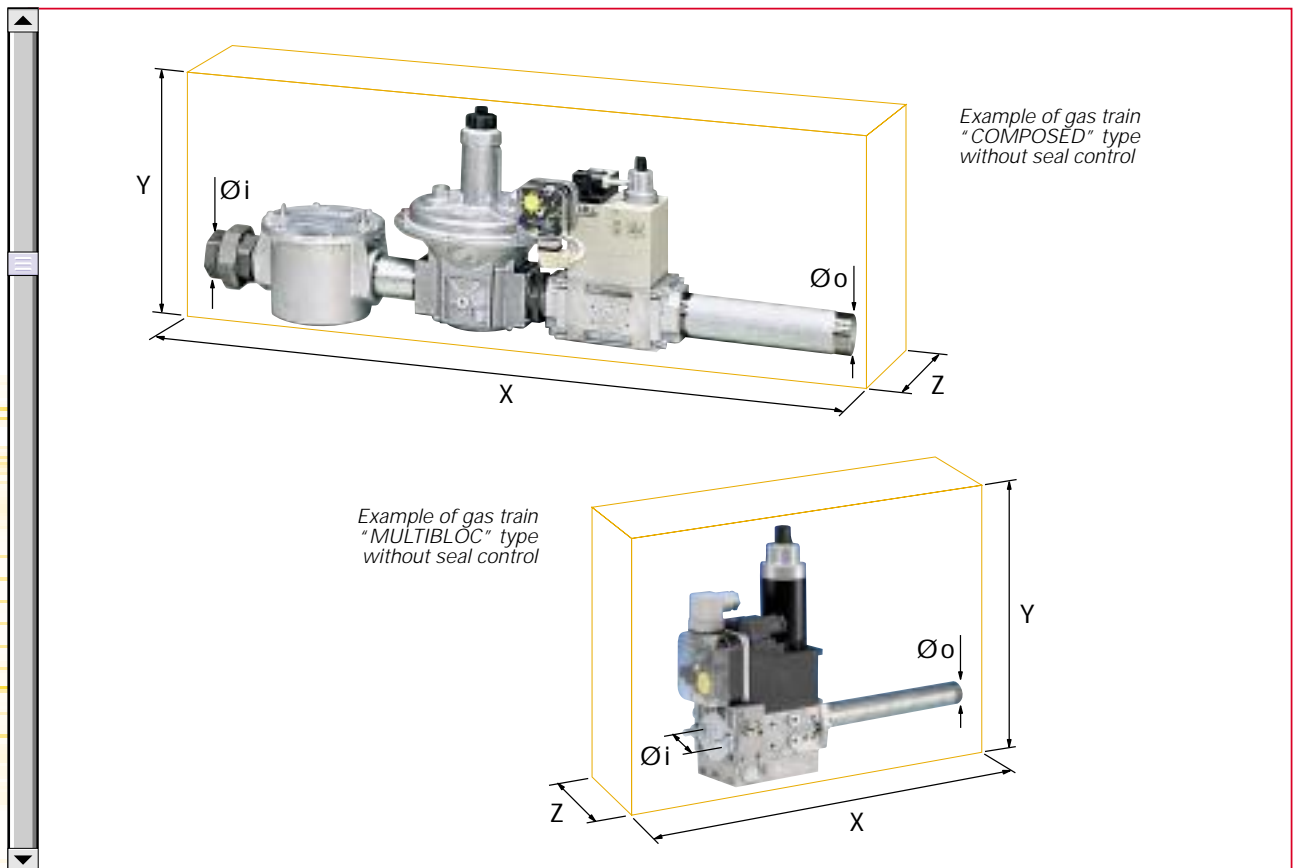

Gas trains are approved by standard EN 676 together with the burner.

The overall dimensions of the gas train depends on how they are constructed. The following table shows the maximum dimensions of the gas trains that can be fitted to GAS P/M burners, intake and outlet diameters and seal control if fitted.

Please note that the seal control can be installed as an accessory, if not already installed on the gas train.

The maximum gas pressure of gas train "Multibloc" type is 300 mbar, and that one of gas train "Composed" type is 500 mbar.

	Name	Code	Ø i	Ø o	X mm	Y mm	Z mm	Seal Control
MULTIBLOC GAS TRAINS	MBD 407	3970076	3/4"	3/4"	371	196	120	-
	MBD 410	3970077	1"	3/4"	405	217	145	-
	MBD 412	3970144	1" 1/4	1" 1/2	433	217	145	-
	MBD 415	3970180	1" 1/2	1" 1/2	523	250	100	-
	MBD 420	3970181	2"	2"	523	300	100	-
	MBD 420 CT	3970182	2"	2"	523	300	227	Incorporated
COMPOSED GAS TRAINS	CB 40/1	3970145	1" 1/2	1" 1/2	891	261	195	-
	CB 50/1	3970146	2"	2"	986	328	250	-
	CB 50/1 CT	3970160	2"	2"	986	328	320	Incorporated
	CBF 65/1	3970147	DN 65	DN 65	874	356	285	-
	CBF 65/1 CT	3970161	DN 65	DN 65	874	356	285	Incorporated
	CBF 80/1	3970148	DN 80	DN 80	934	416	285	-
	CBF 80/1 CT	3970162	DN 80	DN 80	934	416	285	Incorporated
	CBF 100/1	3970149	DN 100	DN 100	1054	501	350	-
CBF 100/1 CT	3970163	DN 100	DN 100	1054	501	350	Incorporated	

PRESSURE DROP DIAGRAM

The diagrams indicate the minimum pressure drop of the burners with the various gas trains that can be matched with them; the value thus calculated represents the minimum required input pressure to the gas train.

NATURAL GAS

GAS 3 P/M

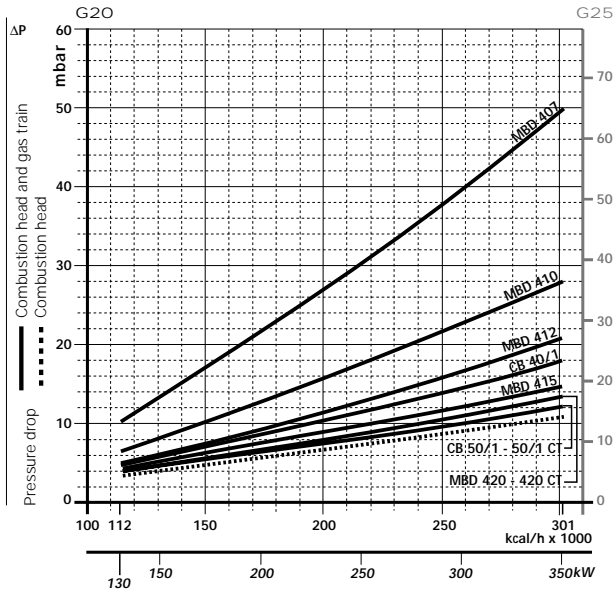

Gas train	Code	Adapter	Seal Control
MBD 407	3970076	3000824	Accessory
MBD 410	3970077	3000824	Accessory
MBD 412	3970144	-	Accessory
MBD 415	3970180	-	Accessory
MBD 420	3970181	3000822	Accessory

LPG

GAS 3 P/M

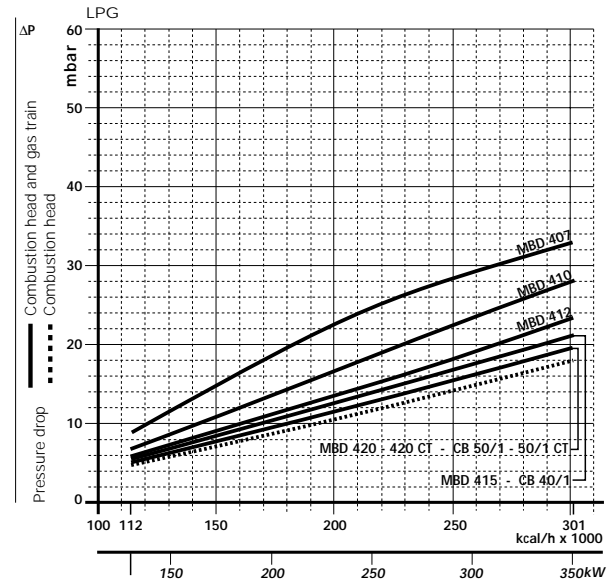

Gas train	Code	Adapter	Seal Control
MBD 420 CT	3970182	3000822	Incorporated
CB 40/1	3970145	-	Accessory
CB 50/1	3970146	3000822	Accessory
CB 50/1 CT	3970160	3000822	Incorporated

GAS 4 P/M

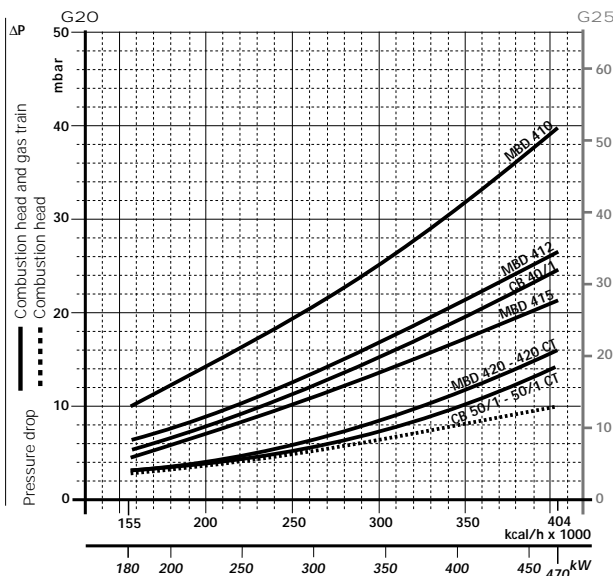

Gas train	Code	Adapter	Seal Control
MBD 410	3970077	3000824	Accessory
MBD 412	3970144	-	Accessory
MBD 415	3970180	-	Accessory
MBD 420	3970181	3000822	Accessory

GAS 4 P/M

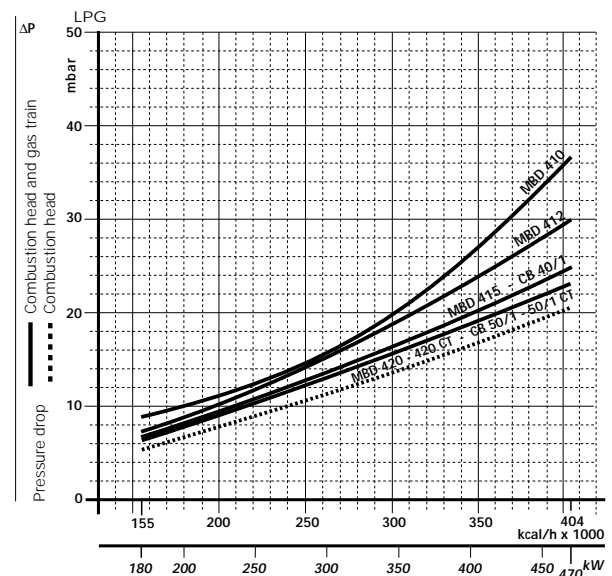

Gas train	Code	Adapter	Seal Control
MBD 420 CT	3970182	3000822	Incorporated
CB 40/1	3970145	-	Accessory
CB 50/1	3970146	3000822	Accessory
CB 50/1 CT	3970160	3000822	Incorporated



NATURAL GAS

LPG

GAS 5 P/M

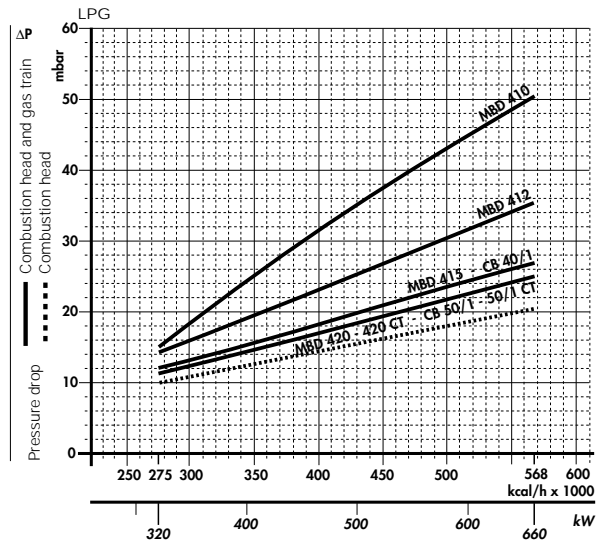
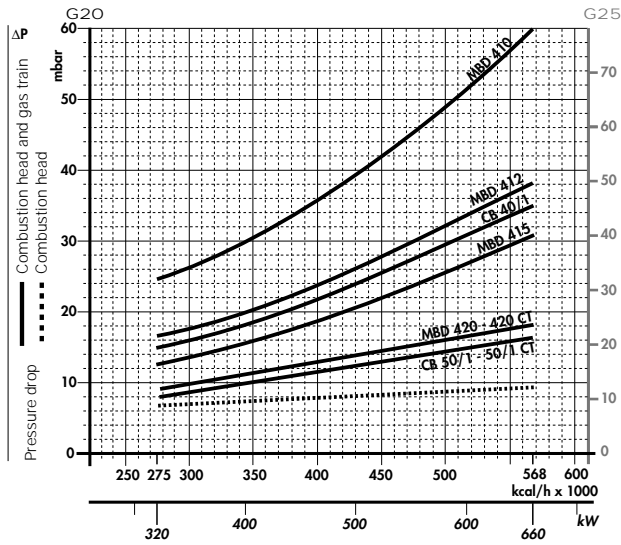

Gas train	Code	Adapter	Seal Control
MBD 410	3970077	3000824	Accessory
MBD 412	3970144	-	Accessory
MBD 415	3970180	-	Accessory
MBD 420	3970181	3000822	Accessory

Gas train	Code	Adapter	Seal Control
MBD 420 CT	3970182	3000822	Incorporated
CB 40/1	3970145	-	Accessory
CB 50/1	3970146	3000822	Accessory
CB 50/1 CT	3970160	3000822	Incorporated

GAS 6 P/M

GAS 6 P/M

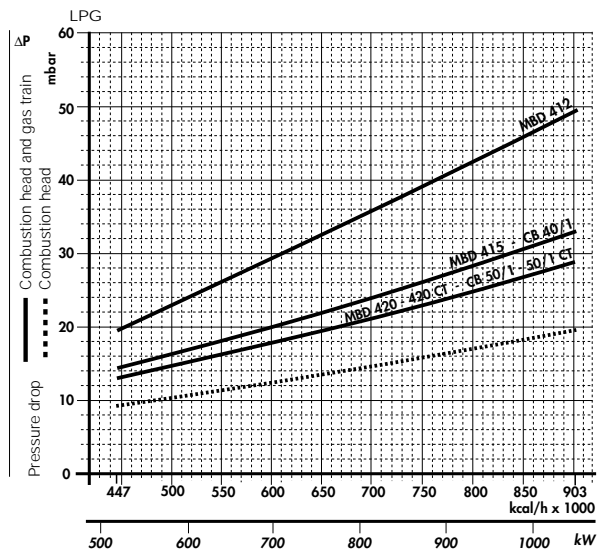
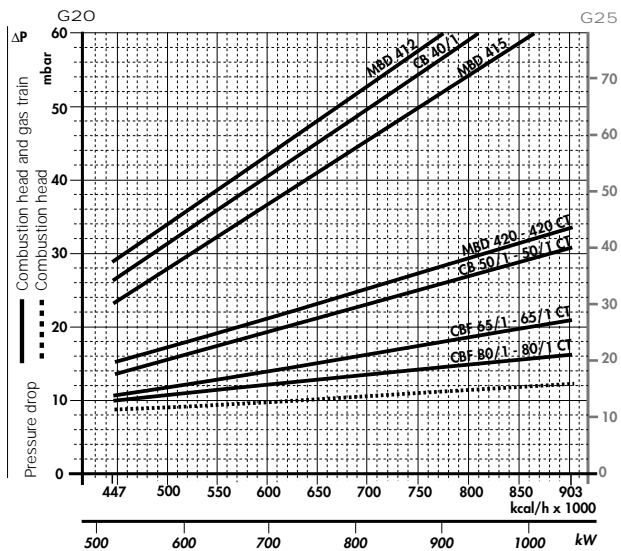

Gas train	Code	Adapter	Seal Control
MBD 412	3970144	3010126	Accessory
MBD 415	3970180	3000843	Accessory
MBD 420	3970181	-	Accessory
MBD 420 CT	3970182	-	Incorporated
CB 40/1	3970145	3000843	Accessory
CB 50/1	3970146	-	Accessory

Gas train	Code	Adapter	Seal Control
CB 50/1 CT	3970160	-	Incorporated
CBF 65/1	3970147	3000825	Accessory
CBF 65/1 CT	3970161	3000825	Incorporated
CBF 80/1	3970148	3000826	Accessory
CBF 80/1 CT	3971062	3000826	Incorporated





NATURAL GAS

GAS 7 P/M

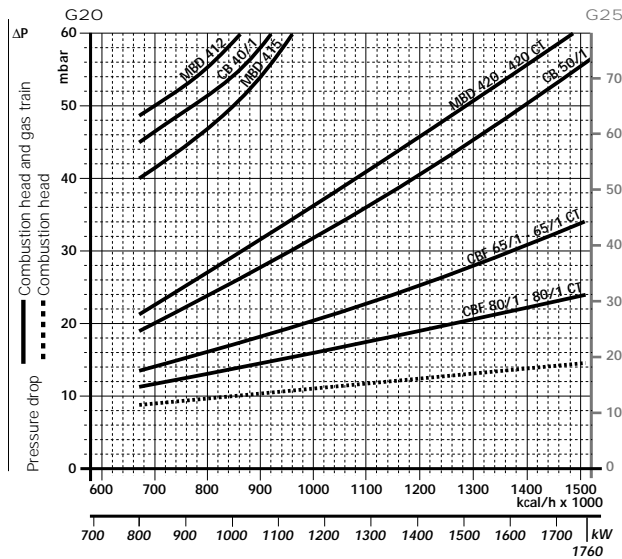

Gas train	Code	Adapter	Seal Control
MBD 412	3970144	3010126	Accessory
MBD 415	3970180	3000843	Accessory
MBD 420	3970181	-	Accessory
MBD 420 CT	3970182	-	Incorporated
CB 40/1	3970145	3000843	Accessory
CB 50/1	3970146	-	Accessory

LPG

GAS 7 P/M

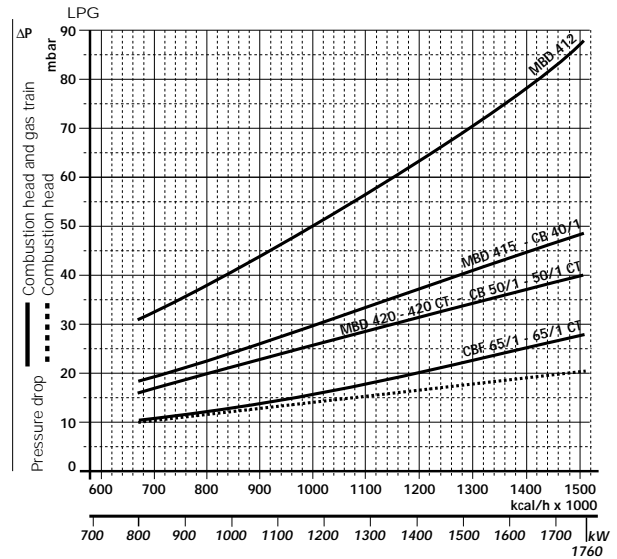

Gas train	Code	Adapter	Seal Control
CB 50/1 CT	3970160	-	Incorporated
CBF 65/1	3970147	3000825	Accessory
CBF 65/1 CT	3970161	3000825	Incorporated
CBF 80/1	3970148	3000826	Accessory
CBF 80/1 CT	3971062	3000826	Incorporated

GAS 8 P/M

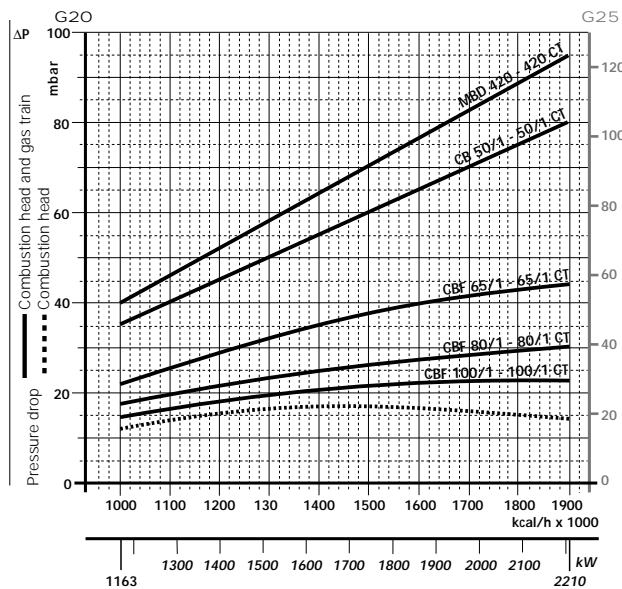

Gas train	Code	Adapter	Seal Control
MBD 420	3970181	3010128	Accessory
MBD 420 CT	3970182	3010128	Incorporated
CB 50/1	3970146	3010128	Accessory
CB 50/1 CT	3970160	3010128	Incorporated
CBF 65/1	3970147	3000831	Accessory

GAS 8 P/M

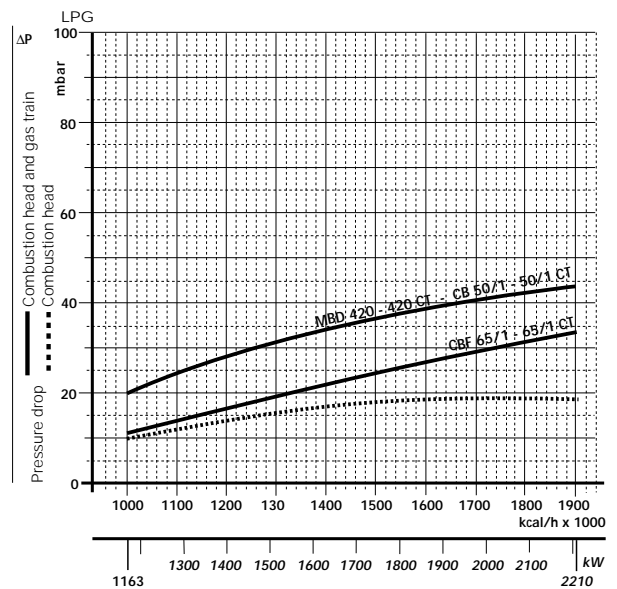

Gas train	Code	Adapter	Seal Control
CBF 65/1 CT	3970161	3000831	Incorporated
CBF 80/1	3970148	3000832	Accessory
CBF 80/1 CT	3971062	3000832	Incorporated
CBF 100/1	3970149	3010127	Accessory
CBF 100/1 CT	3970163	3010127	Incorporated



NATURAL GAS

LPG

GAS 9 P/M

GAS 9 P/M

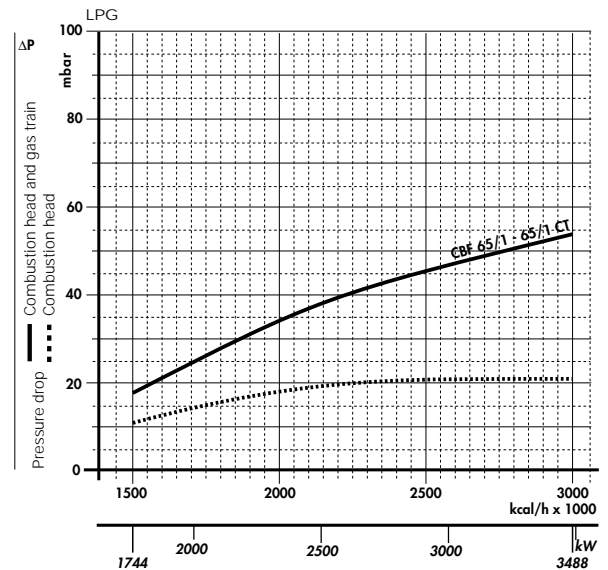
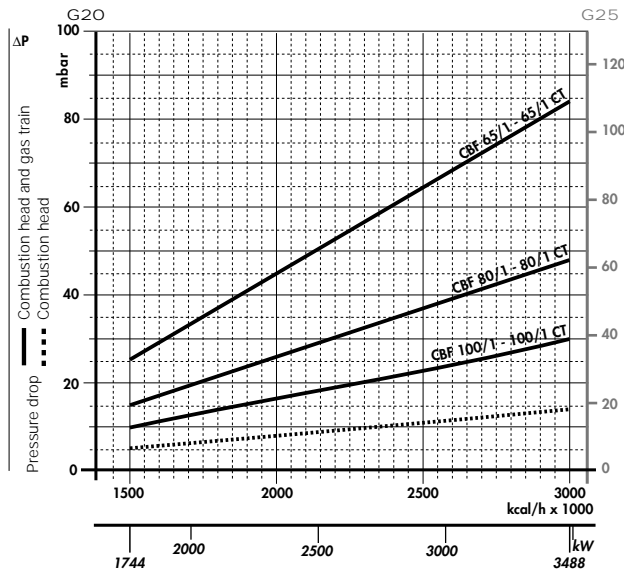

Gas train	Code	Adapter	Seal Control
CBF 65/1	3970147	3000831	Accessory
CBF 65/1 CT	3970161	3000831	Incorporated
CBF 80/1	3970148	3000832	Accessory

Gas train	Code	Adapter	Seal Control
CBF 80/1 CT	3971062	3000832	Incorporated
CBF 100/1	3970149	3010127	Accessory
CBF 100/1 CT	3970163	3010127	Incorporated

GAS 10 P/M

GAS 10 P/M

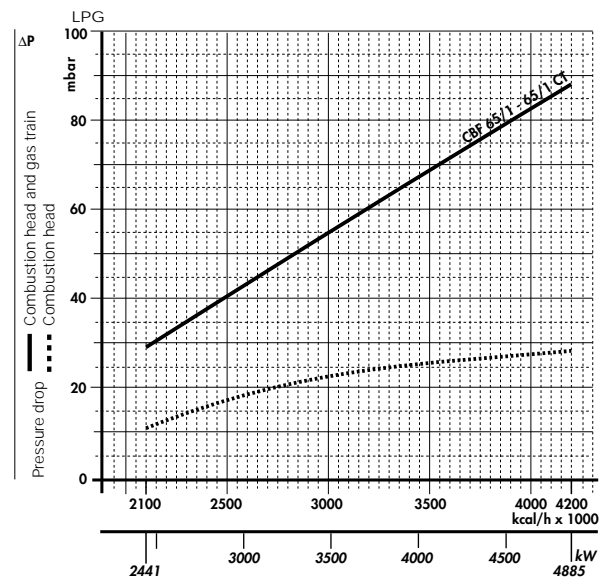
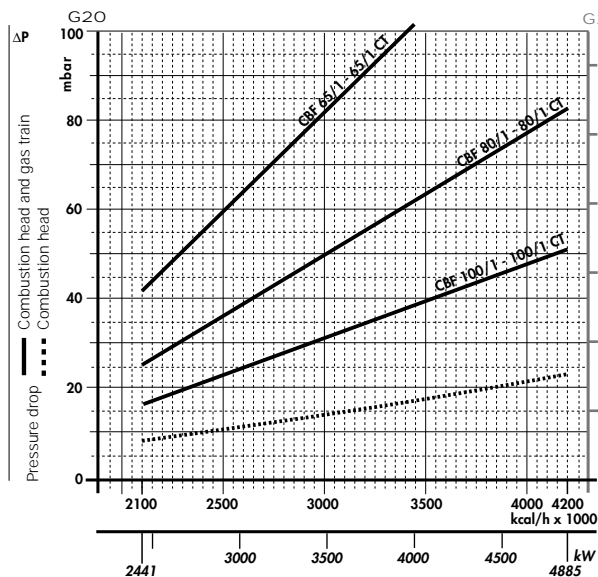

Gas train	Code	Adapter	Seal Control
CBF 65/1	3970147	3000831	Accessory
CBF 65/1 CT	3970161	3000831	Incorporated
CBF 80/1	3970148	3000832	Accessory

Gas train	Code	Adapter	Seal Control
CBF 80/1 CT	3971062	3000832	Incorporated
CBF 100/1	3970149	3010127	Accessory
CBF 100/1 CT	3970163	3010127	Incorporated

note Please contact the Riello Burner Technical Office for different pressure levels from those above indicated.



SELECTING THE FUEL SUPPLY LINES

The following diagram enables pressure drop in a pre-existing gas line to be calculated and to select the correct gas train.

The diagram can also be used to select a new gas line when fuel output and pipe length are known. The pipe diameter is selected on the basis of the desired pressure drop. The diagram uses methane gas as reference; if another gas is used, conversion coefficient and a simple formula (on the diagram) transform the gas output to a methane equivalent (refer to figure A). Please note that the gas train dimensions must take into account the back pressure of the combustion chamber during operations.

Control of the pressure drop in an existing gas line or selecting a new gas supply line. The methane output equivalent is determined by the formula fig. A on the diagram and the conversion coefficient.

Once the equivalent output has been determined on the delivery scale (\dot{V}), shown at the top of the diagram, move vertically downwards until you cross the line that represents the pipe diameter; at this point, move horizontally to the left until you meet the line that represents the pipe length. Once this point is established you can verify, by moving vertically downwards, the pipe pressure drop of on the bottom scale below (mbar).

By subtracting this value from the pressure measured on the gas meter, the correct pressure value will be found for the choice of gas train.

Example: - gas used G25
 - gas output 9.51 mc/h
 - pressure at the gas meter 20 mbar
 - gas line length 15 m
 - conversion coefficient 0.62 (see figure A)

$$\text{- equivalent methane output } \dot{V} = \left[\frac{9.51}{0.62} \right] = 15.34 \text{ mc/h}$$

- once the value of 15.34 has been identified on the output scale (\dot{V}), moving vertically downwards you cross the line that represents 1" 1/4 (the chosen diameter for the piping);
- from this point, move horizontally to the left until you meet the line that represents the length of 15 m of the piping;
- move vertically downwards to determine a value of 1.4 mbar in the pressure drop bottom scale;
- subtract the determined pressure drop from the meter pressure, the correct pressure level will be found for the choice of gas train;
- correct pressure = (20-1.4) = 18.6 mbar

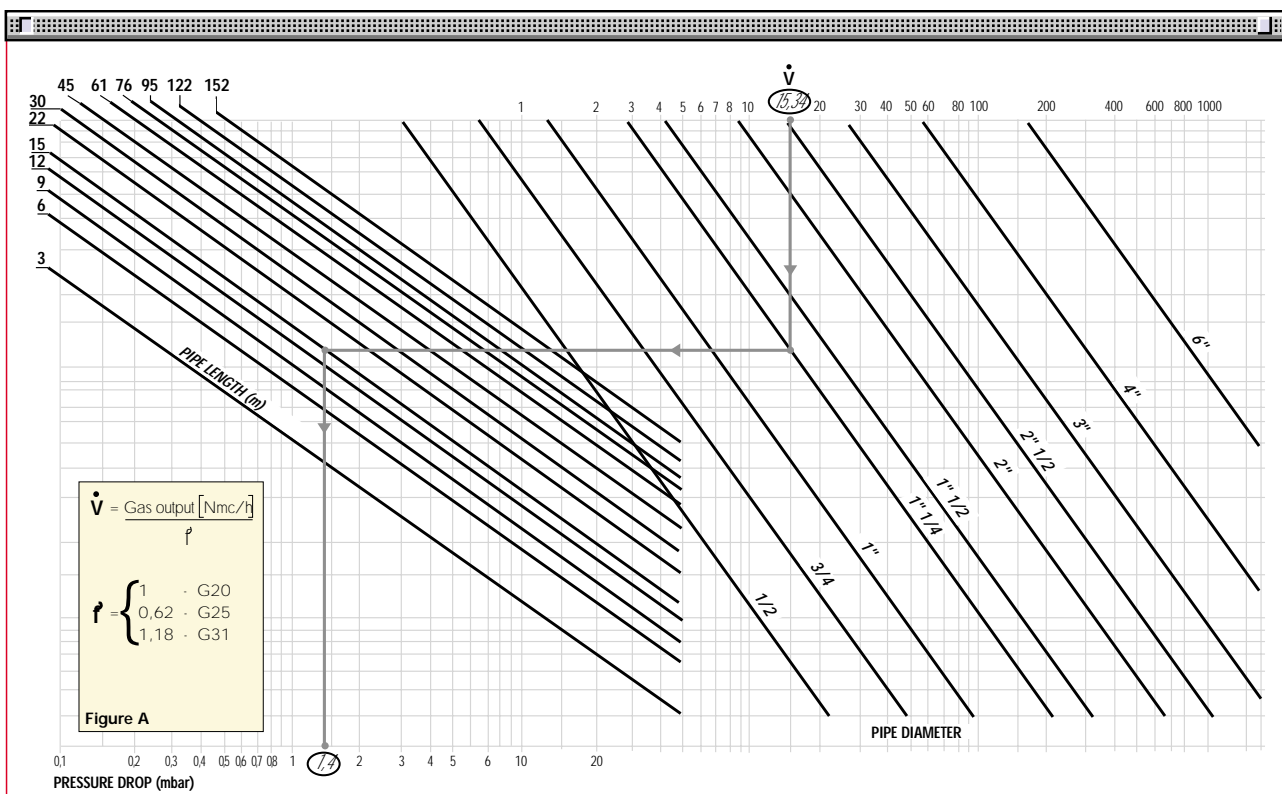

VENTILATION

The ventilation circuit comes with a forward blades centrifugal fan, which guarantees high pressure levels at the required air deliveries and permits installation flexibility.



Example of servomotor and air damper of GAS 3 P/M

In spite of the remarkable output power and of the very high pressure performances, GAS P/M models are extremely compact.

A minimum air pressure switch stops the burner when there is an insufficient quantity of air at the combustion head.

A variable profile cam connects fuel and air setting, ensuring fuel efficiency at all firing rates.

COMBUSTION HEAD

Two different combustion head length can be selected for the various models of GAS P/M series of burners.

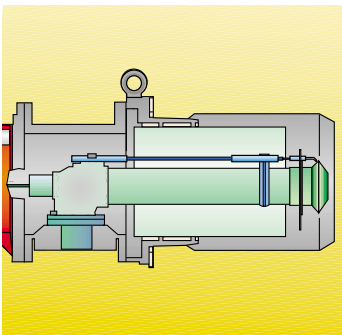

Example of GAS 8 P/M combustion head

The choice depends on the thickness of the front panel and type of boiler. Correct head penetration into the combustion chamber depends on the type of heat generator.

These burners are equipped with a variable geometry combustion head. This enables optimum combustion performance throughout the working field, ensuring peak combustion efficiency thus saving on fuel consumption. The following diagram shows the flame dimensions in relation to the burner output. The lengths and diameter shown in the diagram below should be employed for a preliminary check: if combustion chamber dimensions are different from the values in the diagram, further tests need to be done.

Flame dimensions

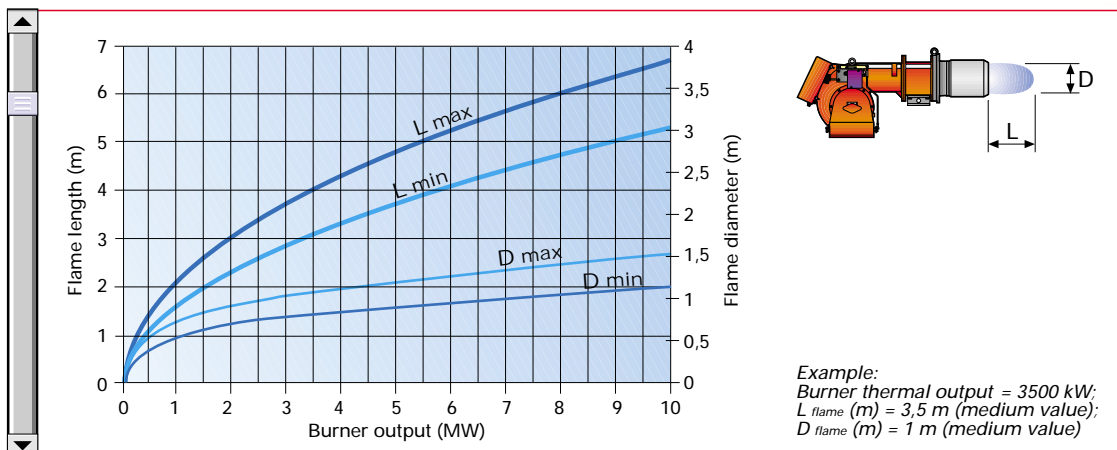

Example:
 Burner thermal output = 3500 kW;
 $L_{flame} (m) = 3,5 m$ (medium value);
 $D_{flame} (m) = 1 m$ (medium value)



ADJUSTMENT

BURNER OPERATION MODE

During "two stage progressive" operation, the burner gradually adapts the output to the requested level, by varying between two pre-set levels (see figure A).

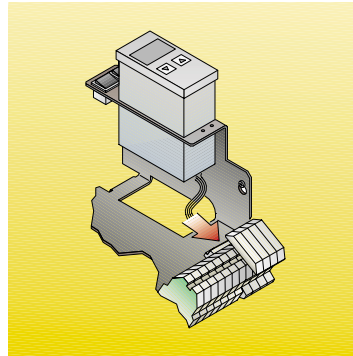

Example of RWF 40 regulator

The GAS P/M series of burners can be "two stage progressive" or "modulating" operation.

"Two stage progressive" operation

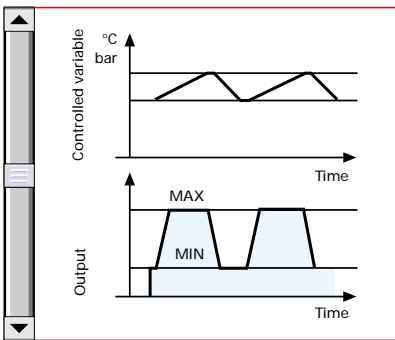

Figure A

During "modulating" operation, normally required in steam generators, in superheated boilers or thermal oil burners, a specific regulator and probes are required. These are supplied as accessories that must be ordered separately. The burner can work for long periods at intermediate output levels (see figure B).

"Modulating" operation

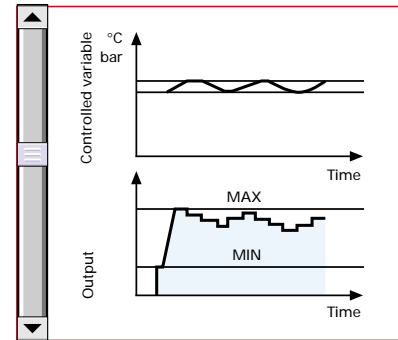
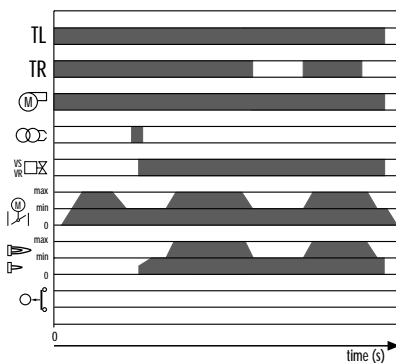

Figure B

START UP CYCLE

GAS 3 P/M - 4 P/M - 5 P/M - 6 P/M - 7 P/M - 8 P/M - 9 P/M - 10 P/M



- 0" The burner begins the firing cycle. Load control TL closes and motor starts running.
- 6" - 51" The servomotor opens the air damper at the maximum output.
- 51" - 82" Pre-purge phase with air delivery at maximum output.
- 82" - 117" The servomotor sets the air damper and the butterfly valve at the minimum output.
- 117" - 120" Pre-ignition.
- 126" Firing : all the solenoid gas valves are supplied.
- 126" - 129" After ignition.
- 150" Output can be increased.

WIRING DIAGRAMS



Electrical connections must be made by qualified and skilled personnel, according to the local regulations.

" TWO STAGE PROGRESSIVE " OPERATION

**GAS 3 P/M - 4 P/M
Without seal control**

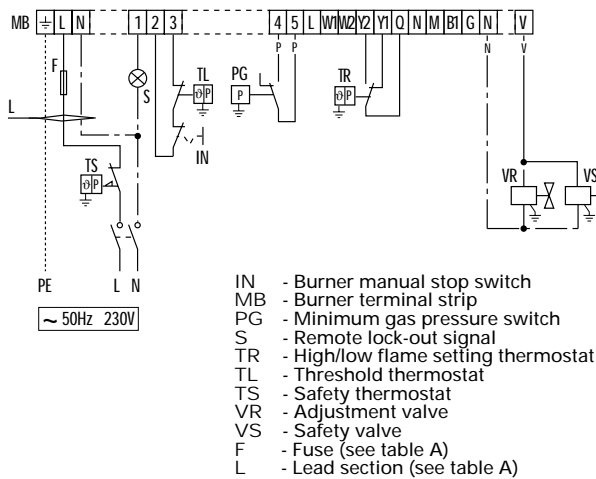

**GAS 5 P/M - 6 P/M - 7 P/M
Without seal control**

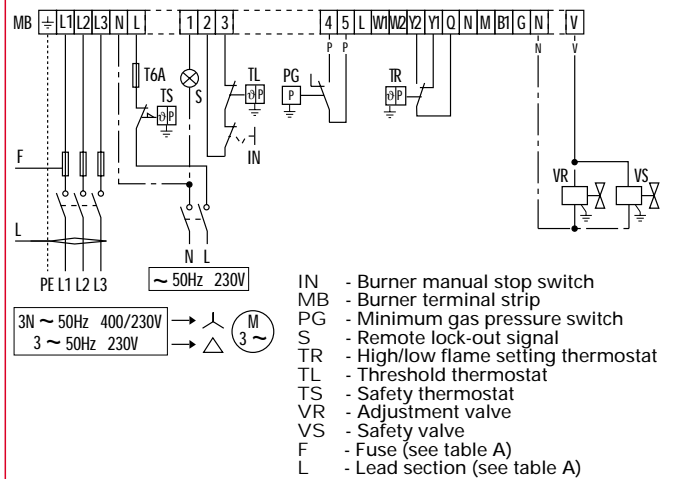

**GAS 3 P/M - 4 P/M
With seal control**

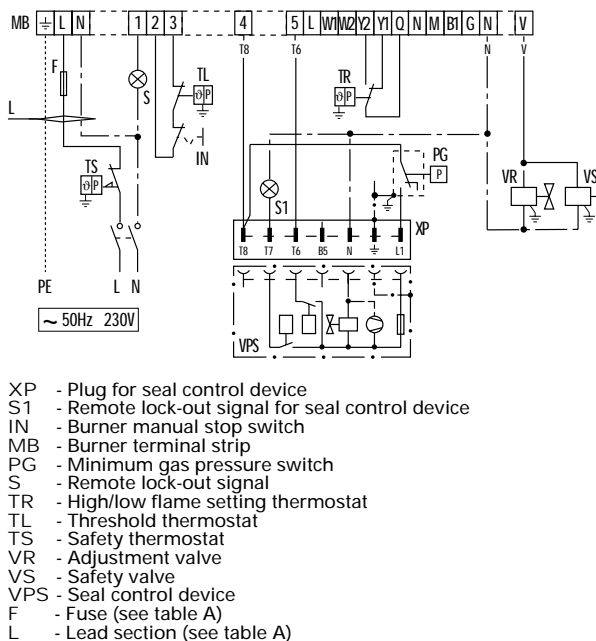

**GAS 5 P/M - 6 P/M - 7 P/M
With seal control**

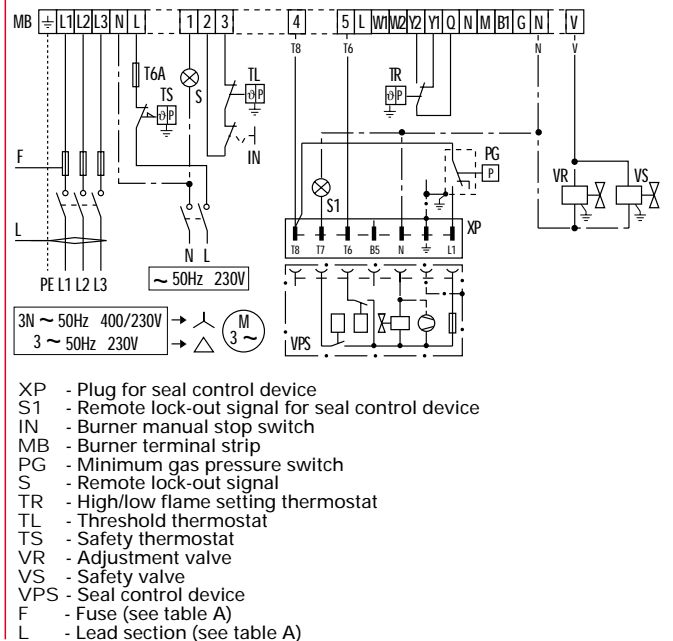

GAS 8 P/M - 9 P/M With seal control - Direct start-up version

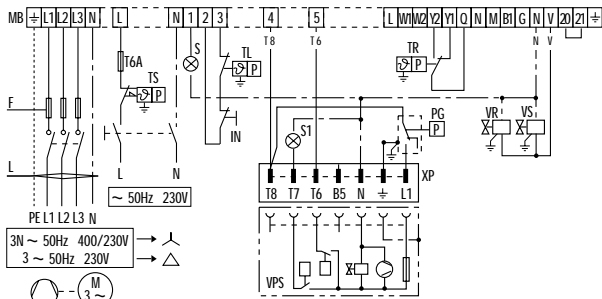

- XP - Plug for seal control device
- S1 - Remote lock-out signal for seal control device
- IN - Burner manual stop switch
- MB - Burner terminal strip
- PG - Minimum gas pressure switch
- S - Remote lock-out signal
- TR - High/low flame setting thermostat
- TL - Threshold thermostat
- TS - Safety thermostat
- VR - Adjustment valve
- VS - Safety valve
- VPS - Seal control device
- F - Fuse (see table B)
- L - Lead section (see table B)

GAS 9 P/M - 10 P/M With seal control - Star-delta start-up version

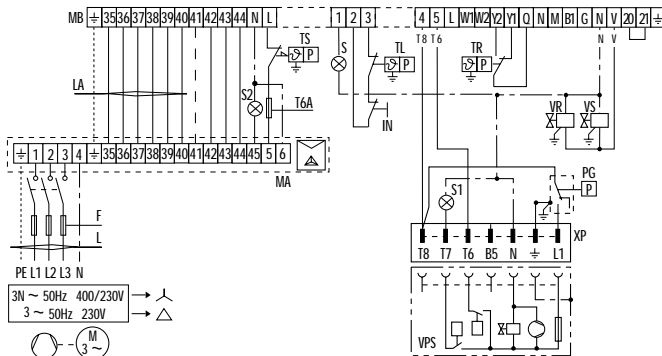

- XP - Plug for seal control device
- S1 - Remote lock-out signal for seal control device
- IN - Burner manual stop switch
- MB - Burner terminal strip
- PG - Minimum gas pressure switch
- S - Remote lock-out signal
- TR - High/low flame setting thermostat
- TL - Threshold thermostat
- TS - Safety thermostat
- VR - Adjustment valve
- VS - Safety valve
- VPS - Seal control device
- MA - Star-delta starter terminal strip
- S2 - Motor strip remote signal
- F - Fuse (see table B)
- L - Lead section (see table B)

"MODULATING" OPERATION – temperature probe

GAS 3 P/M - 4 P/M

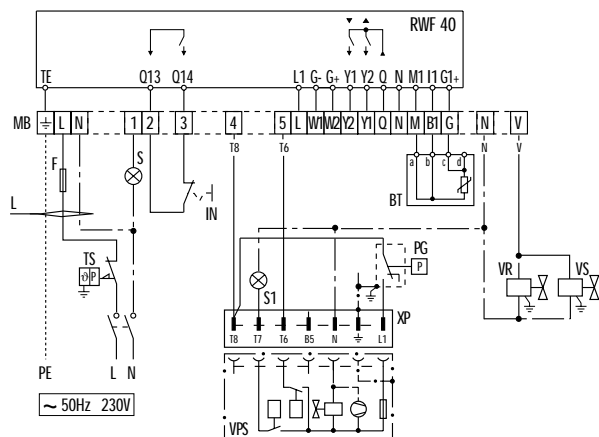

- XP - Plug for seal control device
- S1 - Remote lock-out signal for seal control device
- IN - Burner manual stop switch
- MB - Burner terminal strip
- PG - Minimum gas pressure switch
- S - Remote lock-out signal
- TS - Safety thermostat
- VR - Adjustment valve
- VS - Safety valve
- VPS - Seal control device
- F - Fuse (see table A)
- L - Lead section (see table A)
- BT - Temperature probe
- RWF40 - Regulator (installed on the burner)

GAS 5 P/M - 6 P/M - 7 P/M

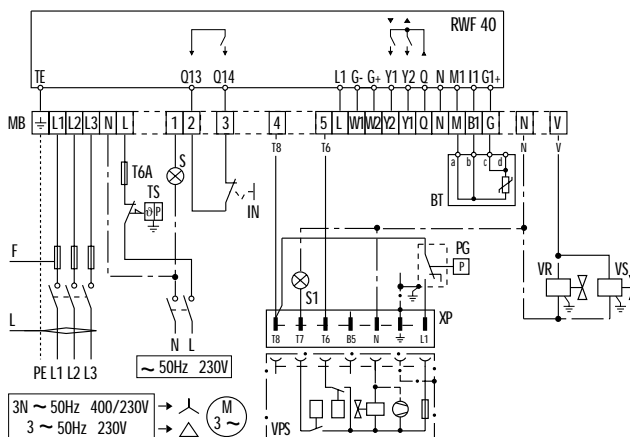

- XP - Plug for seal control device
- S1 - Remote lock-out signal for seal control device
- IN - Burner manual stop switch
- MB - Burner terminal strip
- PG - Minimum gas pressure switch
- S - Remote lock-out signal
- TS - Safety thermostat
- VR - Adjustment valve
- VS - Safety valve
- VPS - Seal control device
- F - Fuse (see table A)
- L - Lead section (see table A)
- BT - Temperature probe
- RWF40 - Regulator (installed on the burner)



GAS 8 P/M - 9 P/M Direct start-up version

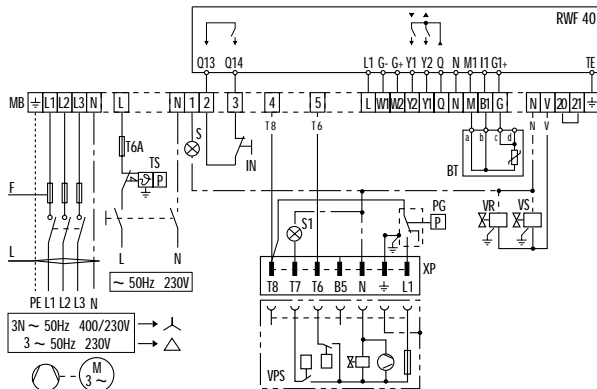

- XP - Plug for seal control device
- S1 - Remote lock-out signal for seal control device
- IN - Burner manual stop switch
- MB - Burner terminal strip
- PG - Minimum gas pressure switch
- S - Remote lock-out signal
- TS - Safety thermostat
- VR - Adjustment valve
- VS - Safety valve
- VPS - Seal control device
- F - Fuse (see table B)
- L - Lead section (see table B)
- BT - Temperature probe
- RWF40 - Regulator (installed on the burner)

GAS 9 P/M 10 P/M Star-delta start-up version

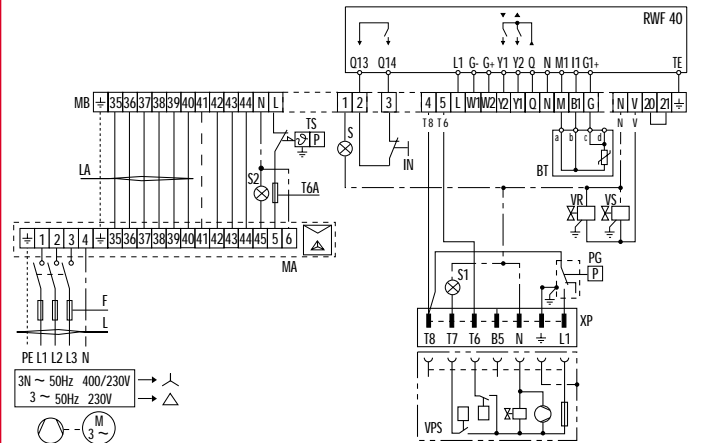

- XP - Plug for seal control device
- S1 - Remote lock-out signal for seal control device
- IN - Burner manual stop switch
- MB - Burner terminal strip
- PG - Minimum gas pressure switch
- S - Remote lock-out signal
- TS - Safety thermostat
- VR - Adjustment valve
- VS - Safety valve
- VPS - Seal control device
- MA - Star-delta starter terminal strip
- S2 - Motor strip remote signal
- F - Fuse (see table B)
- L - Lead section (see table B)
- BT - Temperature probe
- RWF40 - Regulator (installed on the burner)

"MODULATING" OPERATION – pressure probe

GAS 3 P/M - 4 P/M

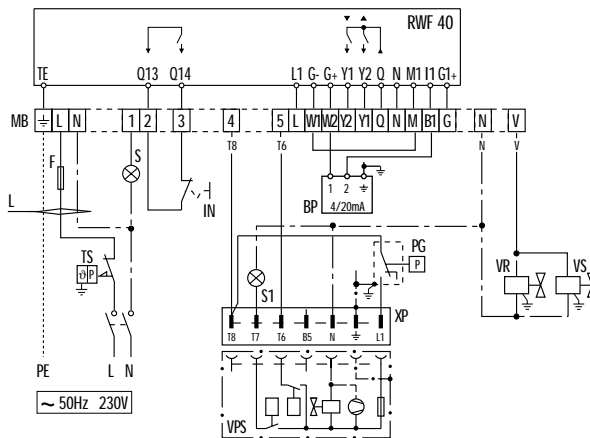

- XP - Plug for seal control device
- S1 - Remote lock-out signal for seal control device
- IN - Burner manual stop switch
- MB - Burner terminal strip
- PG - Minimum gas pressure switch
- S - Remote lock-out signal
- TS - Safety thermostat
- VR - Adjustment valve
- VS - Safety valve
- VPS - Seal control device
- F - Fuse (see table A)
- L - Lead section (see table A)
- BP - Pressure probe
- RWF40 - Regulator (installed on the burner)

GAS 5 P/M - 6 P/M - 7 P/M

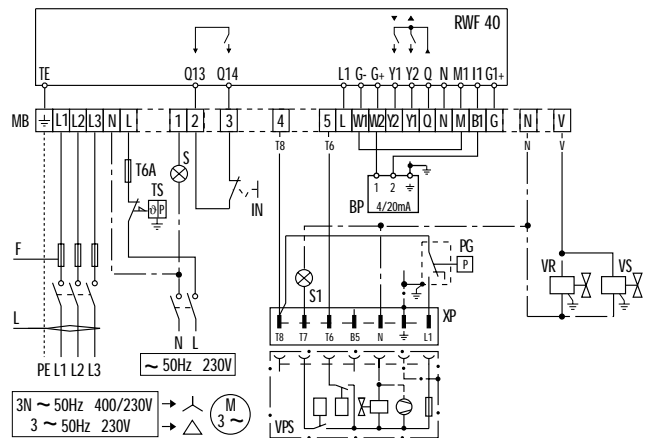

- XP - Plug for seal control device
- S1 - Remote lock-out signal for seal control device
- IN - Burner manual stop switch
- MB - Burner terminal strip
- PG - Minimum gas pressure switch
- S - Remote lock-out signal
- TS - Safety thermostat
- VR - Adjustment valve
- VS - Safety valve
- VPS - Seal control device
- F - Fuse (see table A)
- L - Lead section (see table A)
- BP - Pressure probe
- RWF40 - Regulator (installed on the burner)



GAS 8 P/M - 9 P/M Direct start-up version

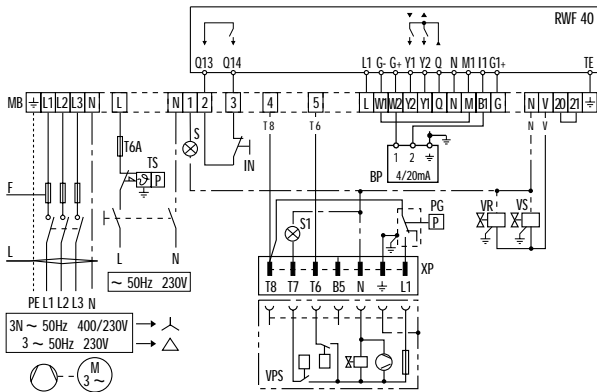

- XP - Plug for seal control device
- S1 - Remote lock-out signal for seal control device
- IN - Burner manual stop switch
- MB - Burner terminal strip
- PG - Minimum gas pressure switch
- S - Remote lock-out signal
- TS - Safety thermostat
- VR - Adjustment valve
- VS - Safety valve
- VPS - Seal control device
- F - Fuse (see table B)
- L - Lead section (see table B)
- BP - Pressure probe
- RWF40 - Regulator (installed on the burner)

GAS 9 P/M 10 P/M Star-delta start-up version

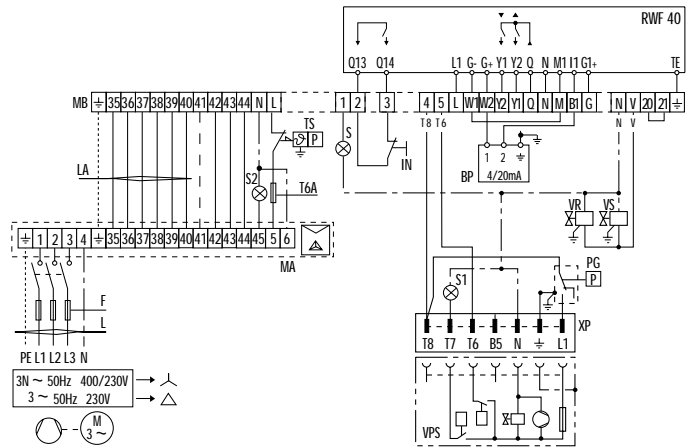

- XP - Plug for seal control device
- S1 - Remote lock-out signal for seal control device
- IN - Burner manual stop switch
- MB - Burner terminal strip
- PG - Minimum gas pressure switch
- S - Remote lock-out signal
- TS - Safety thermostat
- VR - Adjustment valve
- VS - Safety valve
- VPS - Seal control device
- MA - Star-delta starter terminal strip
- S2 - Motor strip remote signal
- F - Fuse (see table B)
- L - Lead section (see table B)
- BP - Pressure probe
- RWF40 - Regulator (installed on the burner)

The following table shows the supply lead sections and the type of fuse to be used.

Model	Single phase		Three phase - Direct start-up					
	▼ GAS 3 P/M	▼ GAS 4 P/M	▼ GAS 5 P/M	▼ GAS 6 P/M	▼ GAS 7 P/M	▼ GAS 8 P/M	▼ GAS 9 P/M	▼ GAS 10 P/M
F A	T5	T6	230V T6	400V T6	230V T16	400V T10	230V T25	400V T16
L mm ²	1,5	1,5	1,5	1,5	1,5	1,5	2,5	1,5

Table A

Model	Three phase - Direct start-up				Three phase - Star-delta start-up			
	▼ GAS 8 P/M	▼ GAS 9 P/M	▼ GAS 9 P/M	▼ GAS 10 P/M	▼ GAS 8 P/M	▼ GAS 9 P/M	▼ GAS 9 P/M	▼ GAS 10 P/M
F A	230V T35	400V T25	230V T50	400V T35	230V T35	400V T25	230V T63	400V T35
L mm ²	4	2,5	6	4	4	2,5	6	4

Table B

EMISSIONS

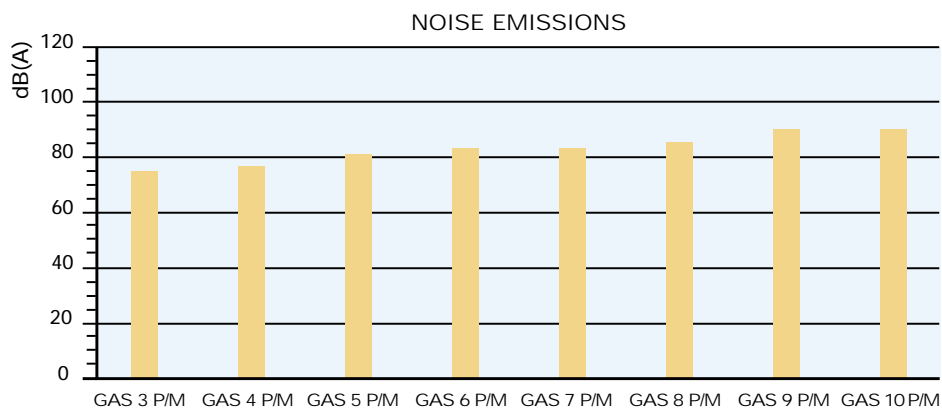
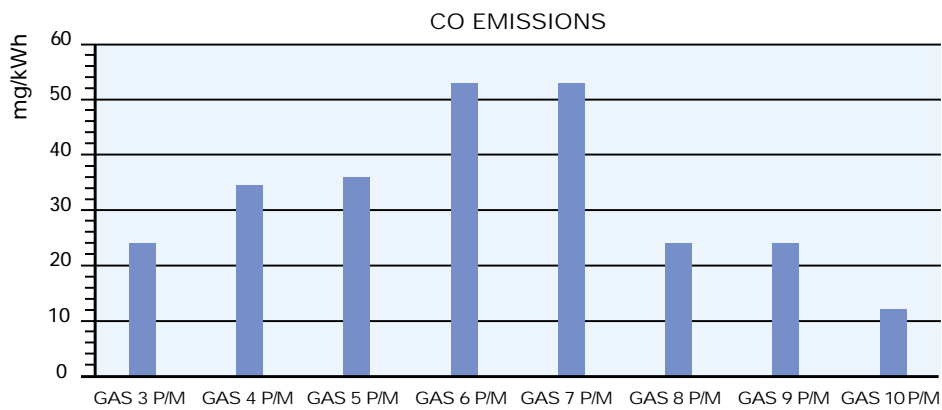
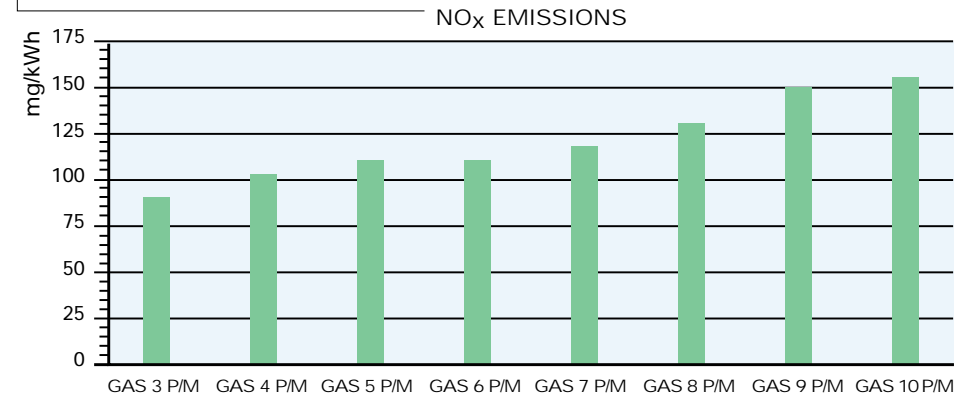

The emission data has been measured in the various models at maximum output, according to EN 676 standard.



OVERALL DIMENSIONS (mm)

BURNERS

GAS 3 P/M - 4 P/M - 5 P/M - 6 P/M - 7 P/M

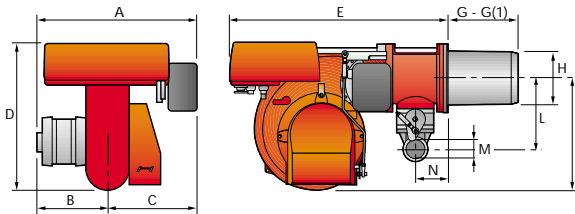

GAS 8 P/M - 9 P/M - 10 P/M

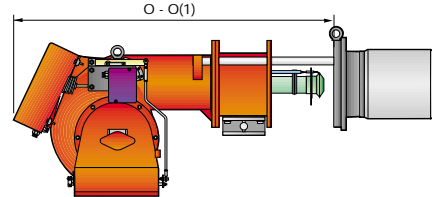
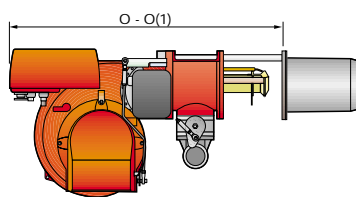
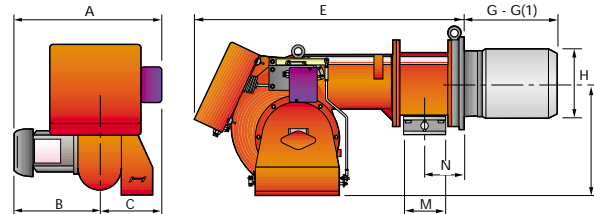

Model	A	B	C	D	E	G - G(1)	H	I	L	M	N	O - O(1)
▶ GAS 3 P/M	585	205	380	397	610	185 - 320	140	292	225	1" 1/2	97	775
▶ GAS 4 P/M	585	205	380	397	610	187 - 320	150	292	225	1" 1/2	97	775
▶ GAS 5 P/M	581	226	355	437	645	207 - 365	155	332	225	1" 1/2	97	810
▶ GAS 6 P/M	628	258	370	485	770	227 - 360	175	370	250	2"	131	966
▶ GAS 7 P/M	758	358	400	590	920	240 - 400	220	445	305	2"	140	1142
▶ GAS 8 P/M	755	396	359	-	1090	391 - 501	260	467	-	DN 80	158	1541 - 1644
▶ GAS 9 P/M	817	447	370	-	1200	444 - 574	295	496	-	DN 80	168	1627 - 1757
▶ GAS 10 P/M	917	508	409	-	1320	476 - 606	336	525	-	DN 80	203	1730 - 1860

(1) Length with extended combustion head

BURNER - BOILER MOUNTING FLANGE

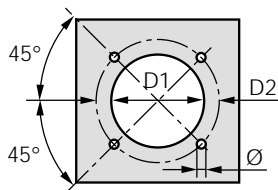

Model	D1	D2	Ø
▶ GAS 3 P/M	155	226	M10
▶ GAS 4 P/M	165	226	M10
▶ GAS 5 P/M	165	226	M10
▶ GAS 6 P/M	185	276	M12
▶ GAS 7 P/M	230	325	M12
▶ GAS 8 P/M	265	368	M16
▶ GAS 9 P/M	300	368	M18
▶ GAS 10 P/M	350	438	M20

PACKAGING

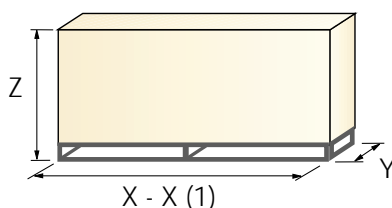

Model	X - X(1)	Y	Z	kg
▶ GAS 3 P/M	930 - -	705	555	37
▶ GAS 4 P/M	930 - -	705	555	43
▶ GAS 5 P/M	930 - -	705	555	46
▶ GAS 6 P/M	1045 - -	705	555	63
▶ GAS 7 P/M	1203 - -	865	665	101
▶ GAS 8 P/M	1690	820	880	195
▶ GAS 9 P/M	1870	920	910	240
▶ GAS 10 P/M	2040	1101	930	290

(1) dimension with extended head

INSTALLATION DESCRIPTION



Installation, start up and maintenance must be carried out by qualified and skilled personnel.

All operations must be performed in accordance with the technical handbook supplied with the burner.

BURNER SETTING

- ▶ All the burners have slide bars, for easier installation and maintenance.
- ▶ After drilling the boilerplate, using the supplied gasket as a template, dismantle the blast tube from the burner and fix it to the boiler.
- ▶ Adjust the combustion head.
- ▶ Fit the gas train, choosing this on the basis of the maximum output of the boiler and considering the enclosed diagrams.
- ▶ Refit the burner casing to the slide bars.
- ▶ Close the burner, sliding it up to the flange.

ELECTRICAL CONNECTIONS AND START UP

- ▶ Make the electrical connections to the boiler following the wiring diagrams included in the instruction handbook.
- ▶ Turn the motor to check rotation direction (if it is a three-phase motor).
- ▶ Perform a first ignition calibration on the gas train.
- ▶ On start up, check:
 - Gas pressure at the combustion head (to max. and min. output)
 - Combustion quality, in terms of unburned substances and excess air.



BURNER ACCESSORIES

Extended head kit

“Standard head” burners can be transformed into “extended head” versions, by using the special kit. The KITS available for the various burners, giving the original and the extended lengths, are listed below.

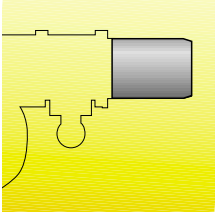

Extended head kit			
Burner	Standard head length (mm)	Extended head length (mm)	Kit code
GAS 3 P/M	185	320	3000605
GAS 4 P/M	187	320	3000606
GAS 5 P/M	207	365	3000607
GAS 6 P/M	227	360	3000608
GAS 7 P/M	240	400	3000609

Spacer kit

If burner head penetration into the combustion chamber needs reducing, varying thickness spacers are available, as given in the following table:

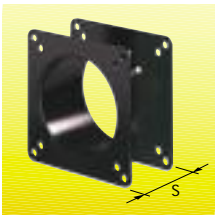

Spacer kit		
Burner	Spacer thickness S (mm)	Kit code
GAS 3 - 4 - 5 - 6 P/M	142	3000755
GAS 7 - 8 P/M	102	3000722
GAS 9 P/M	130	3000723
GAS 10 P/M	130	3000751

Continuous ventilation kit

If the burner requires continuous ventilation in the stages without flame, a special kit is available as given in the following table:



Continuous ventilation kit	
Burner	Kit code
GAS 3 - 4 - 5 - 6 - 7 P/M	3010030

Sound proofing box

If noise emission needs reducing even further, sound-proofing boxes are available, as given in the following table:



Sound proofing box		
Burner	Box type	Box code
GAS 3 - 4 - 5 P/M	C2	3000777
GAS 6 P/M	C3	3000778
GAS 7 P/M	C4	3000779
GAS 8 P/M	C5	3000780
GAS 9 - 10 P/M	C6	3000781



Accessories for modulating operation

To obtain modulating operation, the GAS P/M series of burners requires a regulator with three point outlet controls. The following table lists the accessories for modulating operation with their application range.



Burner	Regulator type	Regulator code
GAS 3 - 4 - 5 - 6 - 7 P/M	RWF 40	3010210
GAS 8 - 9 - 10 P/M	RWF 40	3010211

The relative temperature or pressure probes fitted to the regulator must be chosen on the basis of the application.



Probe type	Range (°C) (bar)	Probe code
Temperature PT 100	-100 ÷ 500°C	3010110
Pressure 4 ÷ 20 mA	0 ÷ 2,5 bar	3010213
Pressure 4 ÷ 20 mA	0 ÷ 16 bar	3010214

Depending on the servomotor fitted to the burner, a three-pole potentiometer (1000 Ω) can be installed to check the position of the servomotor. The KITS available for the various burners are listed below.



Burner	Kit code
GAS 3 - 4 - 5 - 6 - 7 - 8 - 9 - 10 P/M	3010021

LPG kit

For burning LPG gas, a special kit is available to be fitted to the combustion head on the burner, as given in the following table:

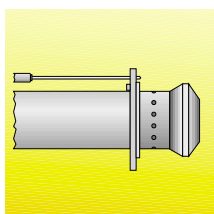









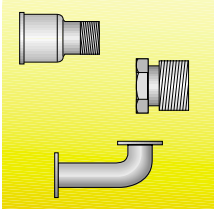









Burner	LPG kit	
	Kit code for standard head	Kit code for extended head
GAS 3 P/M	3000657	3000807
GAS 4 P/M	3000658	3000808
GAS 5 P/M	3000659	3000809
GAS 6 P/M	3000753	3000810
GAS 7 P/M	3000806	3000811
GAS 8 P/M	3000875	3010029
GAS 9 P/M	3000876	3010028
GAS 10 P/M	3010152	3010153

GAS TRAIN ACCESSORIES

Adapters

When the diameter of the gas train is different from the set diameter of the burners, an adapter must be fitted between the gas train and the burner. The following table lists the adapters for various burners.



Adapters			
Burner	Gas train	Dimensions	Adapter code
GAS 3 P/M	MBD 407 - 410	3/4"  1" 1/2	3000824
	MBD 420 - CB 50/1	2"  1" 1/2	3000822
GAS 4 - 5 P/M	MBD 410	3/4"  1" 1/2	3000824
	MBD 420 - CB 50/1	2"  1" 1/2	3000822
GAS 6 - 7 P/M	MBD 412 - 415 - CB 40/1	1" 1/2  2"	3000843
	CB 65	DN 65  2" 1/2  1" 1/2	3000825
	CB 80	DN 80  2" 1/2  2"	3000826
GAS 8 P/M	MBD 420 - CB 50/1	DN 80  DN 65  2" 1/2  2"	3010128
	CB 65	DN 65  DN 80	3000831
	CB 80	DN 80  DN 80	3000832
	CB 100	DN 100  DN 80	3010127
GAS 9 - 10 P/M	CB 65	DN 65  DN 80	3000831
	CB 80	DN 80  DN 80	3000832
	CB 100	DN 100  DN 80	3010127



Seal control kit

To test the valve seals on the gas train, a special "seal control kit" is available. The valve seal control device is compulsory (EN 676) on gas trains to burners with a maximum output over 1200 kW. The sealing control is type VPS 504.



Seal control kit		
Burner	Gas train	Kit code
GAS 3 P/M	MBD 407 - 410 - 412	3010123
	MBD 415 - 420 - CB 40/1 - 50/1	3010125
GAS 4 P/M	MBD 410 - 412	3010123
	MBD 415 - 420 - CB 40/1 - 50/1	3010125
GAS 5 P/M	MBD 410 - 412	3010123
	MBD 415 - 420 - CB 40/1 - 50/1	3010125
GAS 6 P/M	MBD 412	3010123
	MBD 415 - 420 - CB 40/1 - 50/1 - CBF 65/1 - 80/1	3010125
GAS 7 P/M	MBD 412	3010123
	MBD 415 - 420 - CB 40/1 - 50/1 - CBF 65/1 - 80/1	3010125
GAS 8 P/M	MBD 420 - CB 50/1 - CBF 65/1 - 80/1 - 100/1	3010125
GAS 9 P/M	CBF 65/1 - 80/1 - 100/1	3010125
GAS 10 P/M	CBF 65/1 - 80/1 - 100/1	3010125

Stabiliser spring

Accessory springs are available to vary the pressure range of the gas train stabilisers. The following table shows these accessories with their application range

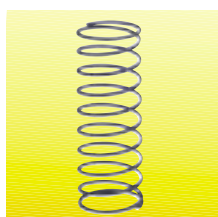

Stabiliser spring		
Gas train	Spring	Spring code
CBF 65/1 - CBF 80/1	Red from 25 to 55 mbar	3010133
CBF 100/1	Red from 25 to 55 mbar	3010134
CBF 65/1 - CBF 80/1	Black from 60 to 110 mbar	3010135
CBF 100/1	Black from 60 to 110 mbar	3010136
CBF 65/1 - CBF 80/1	Pink from 90 to 150 mbar	3090456
CBF 100/1	Pink from 90 to 150 mbar	3090489

Please refer to the technical manual for the correct choice of spring.



SPECIFICATION

A specific index guides your choice of burner from the various models available in the GAS P/M series. Below is a clear and detailed specification description of the product.



DESIGNATION OF SERIES

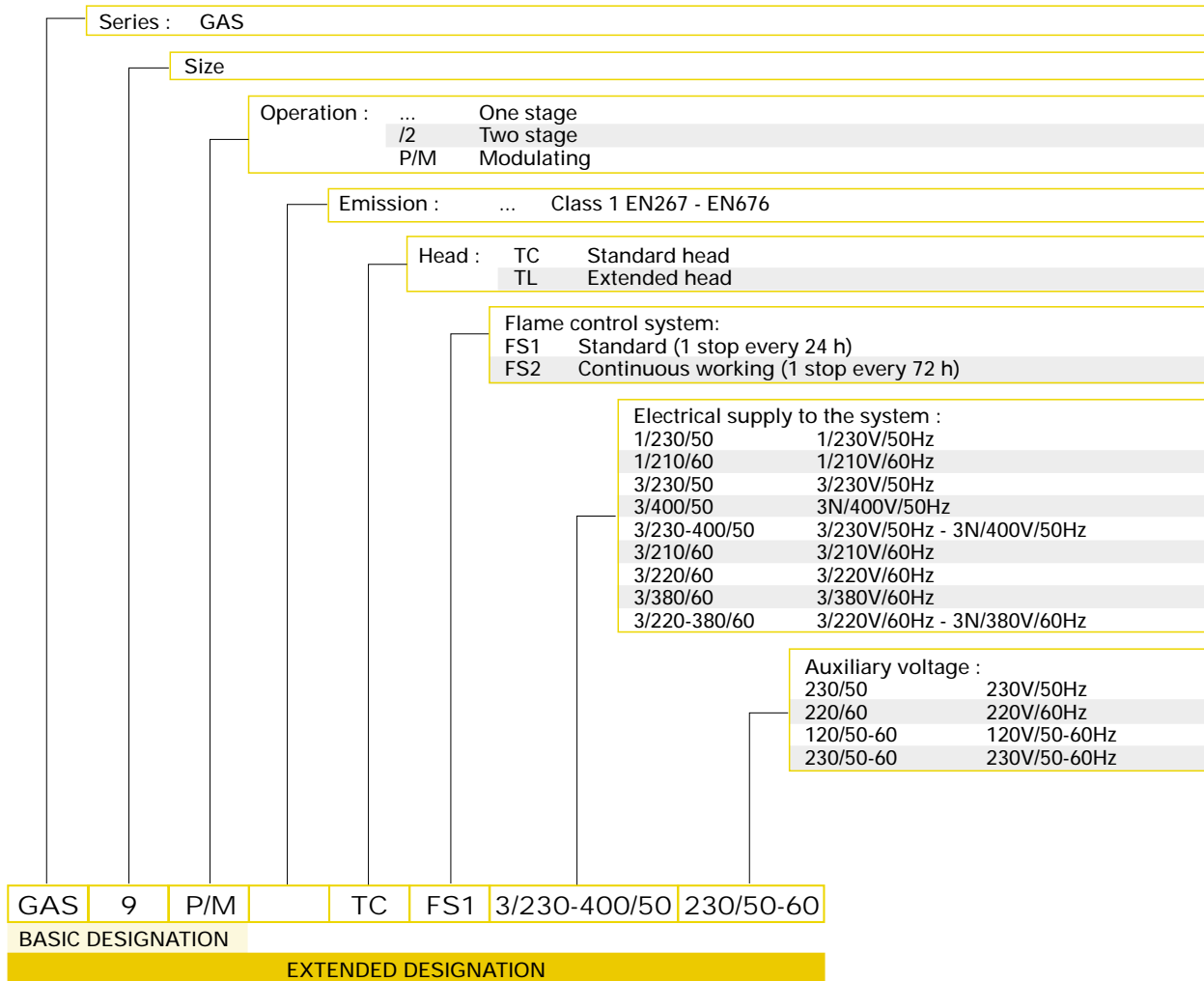



▶ AVAILABLE BURNER MODELS

GAS 3 P/M	TC	FS1	1/210/60	120/50-60	GAS 9 P/M	TC	FS1	3/220-380/60	220/60
GAS 3 P/M	TC	FS1	1/230/50	230/50-60	GAS 9 P/M	TC	FS1	3/230/50	230/50
					GAS 9 P/M	TC	FS1	3/230/50	230/50-60
GAS 4 P/M	TC	FS1	1/230/50	230/50-60	GAS 9 P/M	TC	FS1	3/230-400/50	230/50
GAS 4 P/M	TC	FS1	3/210/60	120/50-60	GAS 9 P/M	TC	FS1	3/230-400/50	230/50-60
GAS 4 P/M	TC	FS1	3/220-380/60	220/60	GAS 9 P/M	TC	FS1	3/400/50	230/50
					GAS 9 P/M	TC	FS1	3/400/50	230/50-60
GAS 5 P/M	TC	FS1	3/210/60	120/50-60	GAS 9 P/M	TL	FS1	3/220-380/60	220/60
GAS 5 P/M	TC	FS1	3/220-380/60	220/60	GAS 9 P/M	TL	FS1	3/230/50	230/50
GAS 5 P/M	TC	FS1	3/230-400/50	230/50-60	GAS 9 P/M	TL	FS1	3/230/50	230/50-60
					GAS 9 P/M	TL	FS1	3/230-400/50	230/50
GAS 6 P/M	TC	FS1	3/210/60	120/50-60	GAS 9 P/M	TL	FS1	3/230-400/50	230/50-60
GAS 6 P/M	TC	FS1	3/220-380/60	220/60	GAS 9 P/M	TL	FS1	3/400/50	230/50
GAS 6 P/M	TC	FS1	3/230-400/50	230/50-60	GAS 9 P/M	TL	FS1	3/400/50	230/50-60
GAS 7 P/M	TC	FS1	3/210/60	120/50-60	GAS 10 P/M	TC	FS1	3/220/60	220/60
GAS 7 P/M	TC	FS1	3/220-380/60	220/60	GAS 10 P/M	TC	FS1	3/230/50	230/50
GAS 7 P/M	TC	FS1	3/230-400/50	230/50-60	GAS 10 P/M	TC	FS1	3/230/50	230/50-60
					GAS 10 P/M	TC	FS1	3/380/60	220/60
GAS 8 P/M	TC	FS1	3/220-380/60	220/60	GAS 10 P/M	TC	FS1	3/400/50	230/50
GAS 8 P/M	TC	FS1	3/230-400/50	230/50	GAS 10 P/M	TC	FS1	3/400/50	230/50-60
GAS 8 P/M	TC	FS1	3/230-400/50	230/50-60	GAS 10 P/M	TL	FS1	3/220/60	220/60
GAS 8 P/M	TL	FS1	3/220-380/60	220/60	GAS 10 P/M	TL	FS1	3/230/50	230/50
GAS 8 P/M	TL	FS1	3/230-400/50	230/50	GAS 10 P/M	TL	FS1	3/230/50	230/50-60
GAS 8 P/M	TL	FS1	3/230-400/50	230/50-60	GAS 10 P/M	TL	FS1	3/380/60	220/60
					GAS 10 P/M	TL	FS1	3/400/50	230/50
					GAS 10 P/M	TL	FS1	3/400/50	230/50-60

Other versions are available on request



▶ PRODUCT SPECIFICATION

Burner:

Monoblock forced draught gas burner, two stage progressive operation or modulating with a kit, made up of:

- Air suction circuit
- Fan with forward curved blades
- Air damper for air setting controlled by a servomotor;
- Combustion head, that can be set on the basis of required output, fitted with:
 - stainless steel end cone, resistant to corrosion and high temperatures
 - ignition electrodes
 - flame stability disk
- Servomotor for air and gas delivery regulation
- Maximum gas pressure switch
- Minimum air pressure switch
- Single phase or three phases electrical motor
- UV photocell for flame detection
- Flame inspection window
- Slide bars for easier installation and maintenance
- Protection filter against radio interference
- IP 40 protection level.

Gas train

Fuel supply line, in the MULTIBLOC configuration (from a diameter of 3/4" until a diameter 2") or COMPOSED configuration (from a diameter of DN 65 until a diameter of DN 100), fitted with:

- Filter
- Stabiliser
- Minimum gas pressure switch
- Safety valve
- Valve seal control (for output > 1200 kW)
- One stage working valve with ignition gas output regulator.

Conforming to:

- 89/336/EEC directive (electromagnetic compatibility)
- 73/23/EEC directive (low voltage)
- 92/42/EEC directive (performance)
- 90/396/EEC directive (gas)
- EN 676 (gas burners).

Standard equipment:

- 1 gas train gasket
- 1 flange gasket
- 1 insulating screen
- 8 screws for fixing the burner flange to the boiler (12 for GAS 8 P/M - GAS 9 P/M and GAS 10 P/M)
- 4 wiring looms for electrical connections
- 1 star delta starter (for GAS 8 P/M - GAS 9 P/M and GAS 10 P/M)
- 2 wiring looms for electrical connections to the star delta starter (for GAS 8 P/M - GAS 9 P/M and GAS 10 P/M)
- 8 washers (for GAS 8 P/M - GAS 9 P/M and GAS 10 P/M)
- 2 bar extensions (only for long head versions of GAS 8 P/M - GAS 9 P/M and GAS 10 P/M)
- Instruction handbook for installation, use and maintenance
- Spare parts catalogue.

Available accessories to be ordered separately:

- Head extension kit
- Head length reduction kit
- Continuous ventilation kit
- Sound-proofing box
- RWF 40 output regulator
- Pressure probe 0 – 2.4 bar
- Pressure probe 0 – 16 bar
- Temperature probe -100 – 500°C
- Potentiometer kit for the servomotor
- LPG kit
- Gas train adapter
- Seal control kit
- Stabiliser spring.





RIELLO S.p.A. - Via degli Alpini, 1 - 37045 LEGNAGO (VR) Italy
Tel. ++39.0442630111 - Fax ++39.044221980

Internet: <http://www.rielloburners.com> - E-mail: rburners@rielloburners.com



Since the Company is constantly engaged in the production improvement, the aesthetic and dimensional features, the technical data, the equipment and the accessories can be changed.
This document contains confidential and proprietary information of RIELLO S.p.A.
Unless authorised, this information shall not be divulged, nor duplicated in whole or in part.