

DB Series

Industrial Dual Block Oil, Gas and Dual Fuel Burners

DB 4	1000/2500	÷	5000	kW
DB 6	1400/4000	÷	7800	kW
DB 9	1500/5000	÷	9500	kW
DB 12	1700/7000	÷	12500	kW
DB 16	2500/8000	÷	16000	kW
DB 20	3000/10000	÷	20000	kW

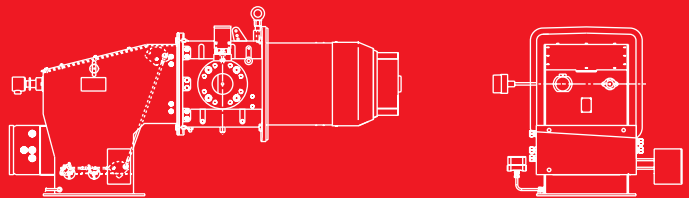

**COMBUSTION
TECHNOLOGY**

ENQUIRIES
National Tel: +27 21 715 3171
Email: info@combustiontechnology.co.za
www.combustiontechnology.co.za



RIELLO
Energy For Life

The new DB burners platform represents the evolution in Riello Burners industrial product range. They are dual block burners for application in big plants (district heating, hospitals) as well as in food, chemicals, textile industry for matching with hot water boilers, steam and thermal oil generators. DB series burners can be supplied with electronic or mechanical air-fuel ratio control according to customer specification. DB 9-12-16-20 are equipped with pilot ignition, while for DB 4-6 models it can be supplied on demand. DB series can work with pre-heated air up to 150°C as standard, up to 250°C with special construction. New variable geometry combustion head allows to reach < 80 mg/kWh NOx emission on natural gas operations. An hinge system for easier combustion head maintenance is available on all models. As part of the offer, various accessories (air fan, control panels, high pressure gas train, etc) are available.

Technical Data

MODEL			DB 4	DB 6	DB 9
Burner operation mode			modulating		
Modulation ratio at max output	natural gas		1:5	1:5	1:6
	LPG		1:4	1:5	1:5
	light oil		1:4	1:4	1:4
	heavy oil		1:3	1:3	1:3
Servomotor	type - mechanical cam		SQM 10	SQM 10	SQM 20
	type - electronic cam		SQM 40 / SQM 48		
Heat output	natural gas	kW	1000/2500÷5000	1400/4000÷7800	1500/5000÷9500
	LPG	kW	1200/2500÷5000	1600/4000÷7800	1900/5000÷9500
	light oil	kW	1250/2500÷5000	1950/4000÷7800	2400/5000÷9500
	heavy oil	kW	1650/2500÷5000	2600/4000÷7800	3150/5000÷9500
Working temperature	min./max.	°C	-15/+150°C (250°C for special versions)		
FUEL/AIR DATA					
Light oil	net calorific value	kWh/kg	11,8		
		Kcal/kg	10200		
	viscosity at 20°C	mm ² /s (cSt)	4 ÷ 6		
	delivery	kg/h	106/212 - 424	165/339 - 661	203/424 - 805
	fuel temperature	max. °C	50		
Heavy oil	net calorific value	kWh/kg	11,1÷11,3		
		Kcal/kg	9545÷9720		
	viscosity at 50°C	mm ² /s (cSt)	500		
	delivery	kg/h	148/224 - 448	233/358 - 699	282/448 - 851
	fuel temperature	max. °C	140		
Atomizing pressure		bar	25÷30 mechanical atomisation / 8÷10 air/steam atomising		
Natural gas (G20)	net calorific value	kWh/kg	10		
	density	kg/Nm ³	0,71		
	gas delivery	Nm ³ /h	100/250 - 500	140/400 - 780	150/500 - 950
Natural gas (G25)	net calorific value		8,6		
	density	kg/Nm ³	0,78		
	gas delivery	Nm ³ /h	116/291 - 581	163/465 - 907	174/581 - 1105
LPG	net calorific value		25,8		
	density	kg/Nm ³	2,02		
	gas delivery	Nm ³ /h	47/97 - 194	62/155 - 302	74/194 - 368
ELECTRICAL DATA					
Electrical supply		Ph/Hz/V	1/50-60/230 - (1/50-60/110 on request)		
Control box		type	LFL 1.333 - LFL 1.335 (Intermittent operation) - LGK 16 (Continuous operation) - LMV 51 - LMV 52		
Auxiliary electrical power		kW	0,63		
Total current		A	2,7 - 5,7		
Protection level		IP	54		
Ignition transformer	V1 - V2		230V - 1x8 kV (230 V - 2x6 kV only DB 4-DB 6 oil version)		
	I1 - I2		1,4A - 30 mA (2,3A - 35 mA only DB 4-DB 6 oil version)		
Operation	Intermittent (at least one stop every 24 h) - Continuous (at least one stop every 72 h)				
EMISSIONS					
Light oil	CO emission	mg/kWh	< 110		
	smoke index	N° Bacharach	< 1 for maximum output		
	NOx emission	mg/kWh	< 185 for C20 and C23 versions		

MODEL			DB 4	DB 6	DB 9
Heavy oil	CO emission	mg/kWh	Depending on the fuel composition		
	smoke index	N° Bacharach	Depending on the fuel composition		
	NOx emission	mg/kWh	Depending on the fuel composition		
G20	CO emission	mg/kWh	< 100		
	NOx emission	mg/kWh	< 80 for C03 and C23 versions		
APPROVAL					
Directive			2006/42 - 2009/142 - 2004/108 - 2006/95 EC		
Conforming to Certification			EN 267 - EN 676		
			--		
MODEL			DB 12	DB 16	DB 20
Burner operation mode			modulating		
Modulation ratio at max output	natural gas		1:6	1:6	1:6
	LPG		1:5	1:5	1:6
	light oil		1:4	1:4	1:4
	heavy oil		1:3	1:3	1:3
Servomotor	type - mechanical cam		SQM 10 (1) SQM 20 (2)	SQM 50	SQM 50
	type - electronic cam		SQM 45 / SQM 48		
Heat output	natural gas	kW	1700/7000÷12500	2500/8000÷16000	3000/10000÷20000
	LPG	kW	2100/7000÷12500	3100/8000÷16000	3600/10000÷20000
	light oil	kW	3200/7000÷12500	4000/8000÷16000	5000/10000÷20000
	heavy oil	kW	4150/7000÷12500	5300/8000÷16000	6600/10000÷20000
Working temperature	min./max.	°C	-15/+150°C (250°C for special versions)		
FUEL/AIR DATA					
Light oil	net calorific value	kWh/kg Kcal/kg	11,8 10200		
	viscosity at 20°C	mm ² /s (cSt)	4 ÷ 6		
	delivery	kg/h	271/593 - 1059	339/678 - 1356	424/847 - 1695
	fuel temperature	max. °C	50		
	Heavy oil	net calorific value	kWh/kg Kcal/kg	11,1÷11,3 9545÷9720	
viscosity at 50°C		mm ² /s (cSt)	500		
delivery		kg/h	372/627 - 1120	475/717 - 1434	590/896 - 1792
fuel temperature		max. °C	140		
Atomizing pressure		bar	25÷30 mechanical atomisation / 8÷10 air/steam atomising		
Natural gas (G20)	net calorific value	kWh/kg	10		
	density	kg/Nm ³	0,71		
	gas delivery	Nm ³ /h	170/700 - 1250	250/800 - 1600	300/1000 - 2000
Natural gas (G25)	net calorific value		8,6		
	density	kg/Nm ³	0,78		
	gas delivery	Nm ³ /h	198/814 - 1453	291/930 - 1860	349/1163 - 2326
LPG	net calorific value		25,8		
	density	kg/Nm ³	2,02		
	gas delivery	Nm ³ /h	81/271 - 484	120/310 - 620	140/388 - 775
ELECTRICAL DATA					
Electrical supply		Ph/Hz/V	1/50-60/230 - (1/50-60/110 on request)		

MODEL		DB 12	DB 16	DB 20
Control box	type	LFL 1.333 - LFL 1.335 (Intermittent working) - LGK 16 (Continuous working) - LMV 51 - LMV 52 Lamtec Etamatic		
Auxiliary electrical power	kW	0,63		
Total current	A	2,7 - 5,7		
Protection level	IP	54		
Ignition transformer	V1 - V2	230V - 1x8 kV (230 V - 2x6 KV only DB 4-DB 6 oil version)		
	I1 - I2	1,4A - 30 mA (2,3A - 35 mA only DB 4-DB 6 oil version)		
Operation		Intermittent (at least one stop every 24 h) - Continuous (at least one stop every 72 h)		
EMISSIONS				
Light oil	CO emission	mg/kWh	< 110	
	smoke index	N° Bacharach	< 1 for maximum output	
	NOx emission	mg/kWh	< 185 for C20 and C23 versions	
Heavy oil	CO emission	mg/kWh	Depending on the fuel composition	
	smoke index	N° Bacharach	Depending on the fuel composition	
	NOx emission	mg/kWh	Depending on the fuel composition	
G20	CO emission	mg/kWh	< 100	
	NOx emission	mg/kWh	< 80 for C03 and C23 versions	
APPROVAL				
Directive		2006/42 - 2009/142 - 2014/30 - 2014/35		
Conforming to		EN 267 - EN 676		
Certification		--		

(1) for single fuel versions

(2) for dual fuel versions

Reference conditions:

Temperature: 20°C - Pressure: 1013,5 mbar - Altitude: 0 m a.s.l. - Noise measured at a distance of 1 meter.

Since the Company is constantly engaged in the production improvement, the aesthetic and dimensional features, the technical data, the equipment and the accessories can be changed. This document contains confidential and proprietary information of RIELLO S.p.A. Unless authorised, this information shall not be divulged, nor duplicated in whole or in part.

Firing Rates

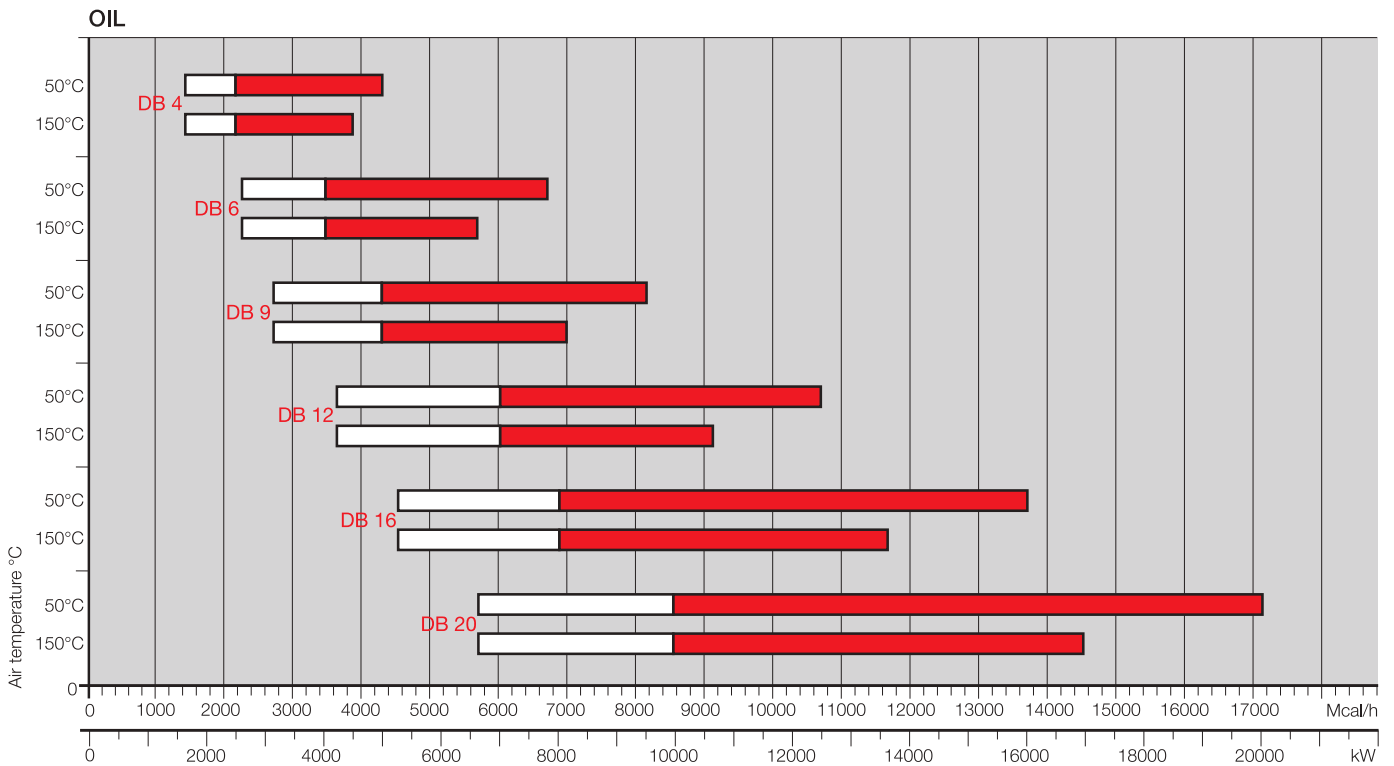
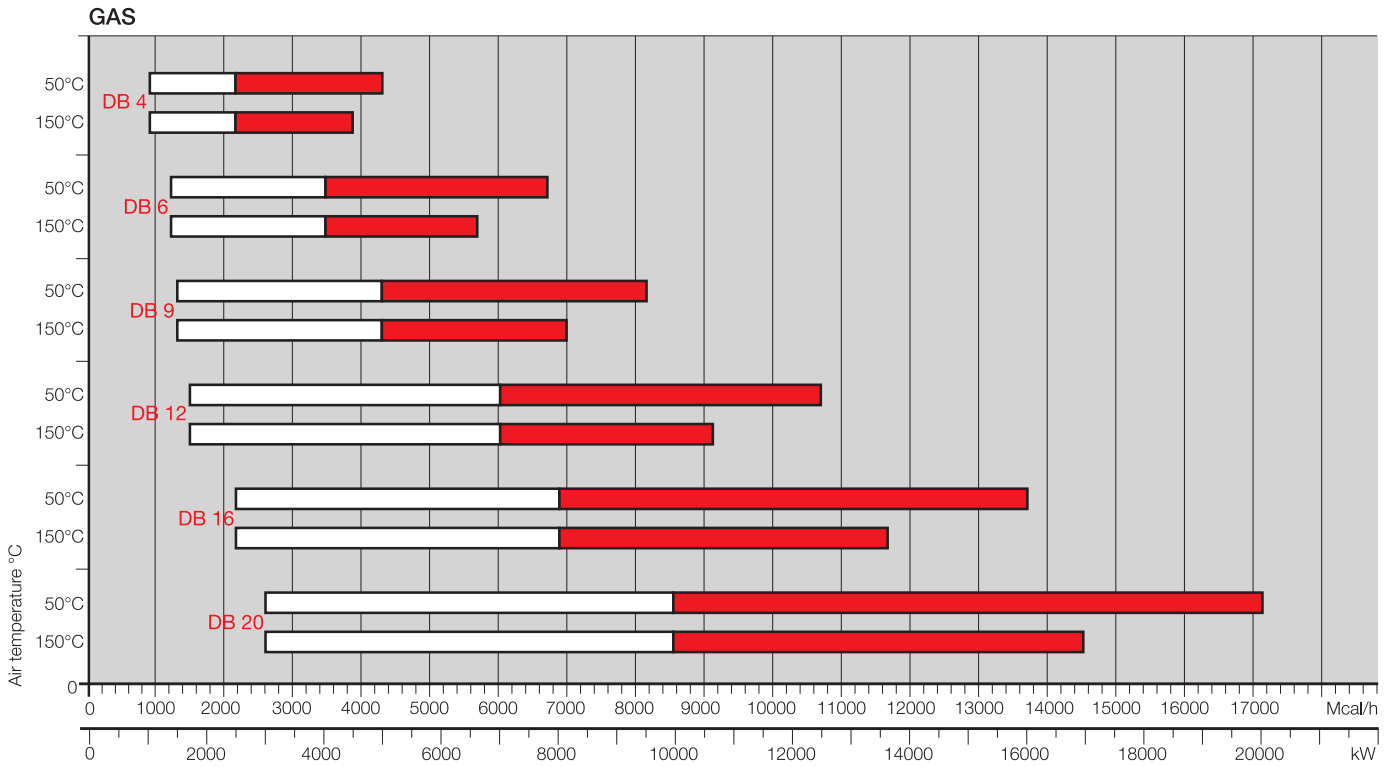

Test conditions conforming EN 267; EN 676:
 Temperature: 20°C
 Pressure: 1013.5 mbar
 Altitude: 0 m a.s.l.

■ Useful working field for choosing the burner
 Modulating range

Fuel Supply

Example of hydraulic circuit (mechanical cam - mechanical atomisation)

The hydraulic circuit of industrial burner DB series is composed by two main blocks; the first one, on board, includes the emergency and regulation units; the second, separate to the burner, constitutes the pumping group. A variable profile cam connects the regulation of the fuel and the air guaranteeing an elevate combustion efficiency on all firing rates.

AD	Air damper
CL	Oil collector
C1	First adjusting cam
C2	Second adjusting cam
MM	Pressure gauge on the delivery circuit
MR	Pressure gauge on the return circuit
NL	Oil pipe
N	Nozzle
PO	Max. oil pressure switch on the return circuit
RP	Pressure regulator on the return circuit
SM	Servomotor
VS	Safety oil valve
VU	Nozzle safety valve (solenoid electromagnet)
VCL	Nozzle safety valve (pneumatic control - air 5÷7 bar)

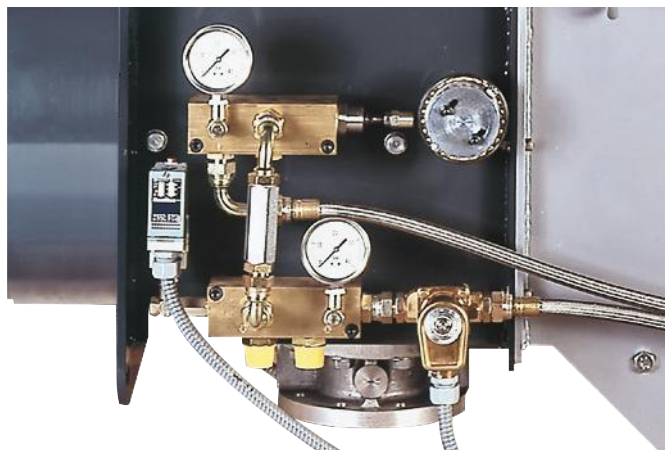

Example of oil unit DB

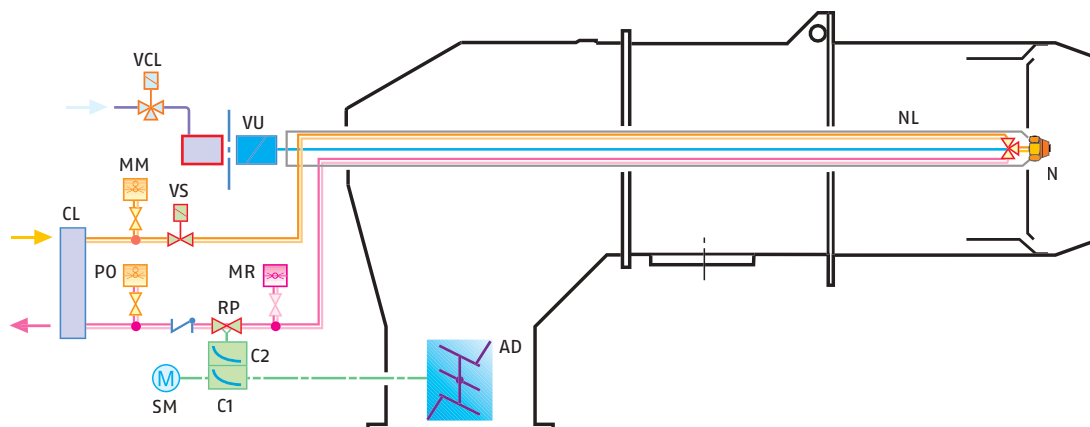

EXAMPLE OF COMPLETE SUPPLY OIL CIRCUIT (steam atomizing)

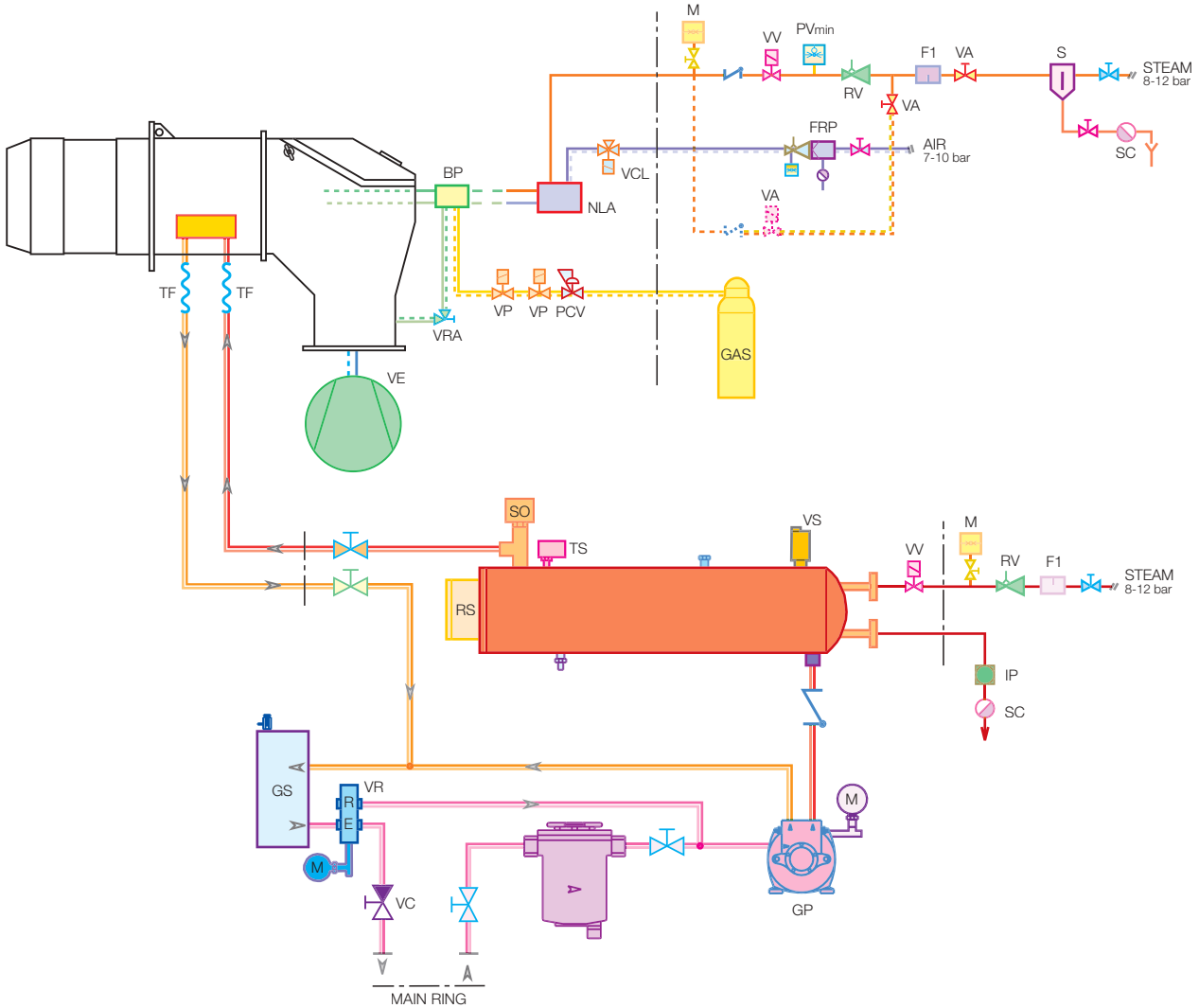

BP	Pilot burner
ELV	Electric/steam oil preheater
F	Self-cleaning filter
FRP	Air pressure regulation filter
F1	Filter
GP	Pump with pressure regulator
A	: suction
BP	: by-pass
S	: delivery
GS	Degassing unit
IP	Condensation passage indicator
PCV	Gas pressure regulator
PVmin	Minimum steam pressure switch
M	Pressure gauge
NLA	Oil lance
RS	Pre-heater heating element

RV	Steam/air pressure regulator
S	Condensation separator
SC	Condensation outlet
SO	Oil temperature probe (PT 100)
TF	Flexible hose
TS	Maximum and minimum oil thermostat
VA	Air/steam adjustment valve (manual selection)
VCL	Oil lance hydraulic control valve
VRA	Air pressure regulation valve
VC	Relief valve (normally closed)
VE	Fan
VP	Pilot valve
VR	Oil pressure regulator valve
VS	Safety valve (maximum pressure)
VV	Steam solenoid valve

NOTE: With ring distribution oil systems, the feasible drawings and dimensioning are the responsibility of specialised engineering studios, who must check compatibility with the requirements and features of each single installation.

EXAMPLE OF COMPLETE SUPPLY GAS LINE

The DB burners series are fitted with a butterfly valve to regulate the fuel, controlled by a variable profile cam servomotor which guarantees, through the association of the air and fuel regulation, high thermal efficiency all over the firing rates.

BP	Pilot burner (DB 9 -12 -16 -20)
GAS	Supply gas line
VE	Fan
PA	Minimum air pressure switch
PGM	Maximum gas pressure switch
RG	Butterfly valve
VP	Pilot gas train valve
PCV	Pilot gas train regulator
VR	Gas train adjusting valve
VPS	Seal control
VS	Gas train safety valve
PGm	Minimum gas pressure switch
C	Anti-vibrant joint
LPG	Low pressure regulator
MM	Pressure gauge
GF	Filter
SRV	Vent safety valve
HPG	High pressure regulator

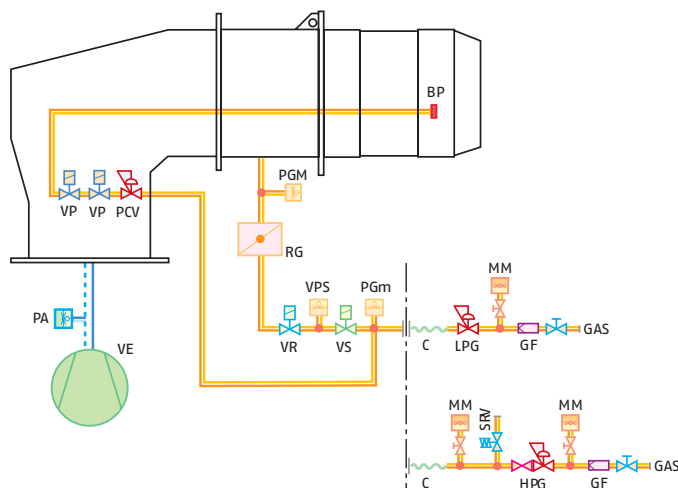

Combustion Head

Different lengths of the combustion head can be chosen for the DB series of burners. The choice depends on the thickness of the front panel and the type of boiler. Depending on the type of generator, check that the penetration of the head into the combustion chamber is correct.



Example of DB low NOx combustion head (gas operation).

COMBUSTION HEAD PRESSURE DROP DIAGRAMS

GAS PRESSURE LOSSES

The following diagrams indicate the gas side losses of the combustion head. Adding to the value of these losses the combustion chamber pressure and total gas train loss, it is obtained the minimal input pressure necessary to the gas train.

Burner head GAS pressure drop (including butterfly valve and ref to G20)
DB - Natural Gas - Low NOx Emissions

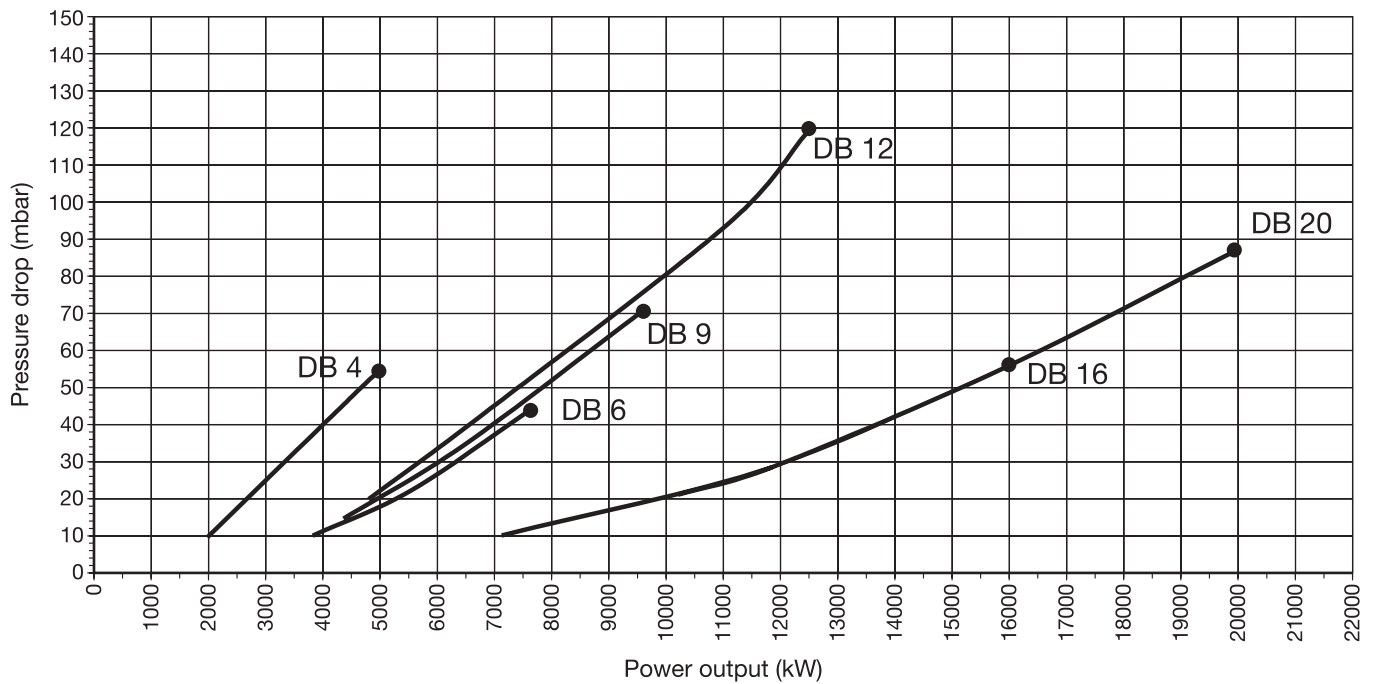

Burner head AIR pressure drop (including air damper - AIR temp = 40°C)
DB - Natural Gas - Low NOx Emissions

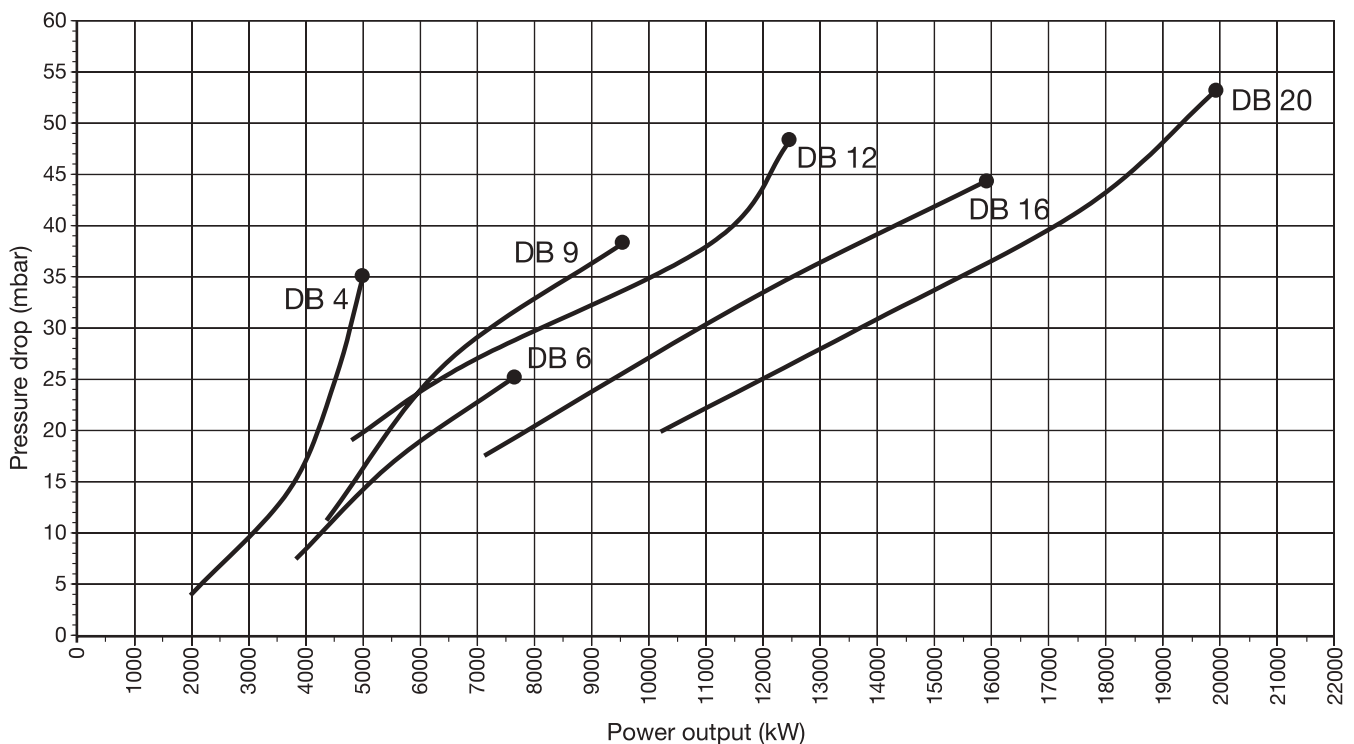

Burner head GAS pressure drop (including butterfly valve and ref to G20)
 DB - All versions except DB gas-low NOx

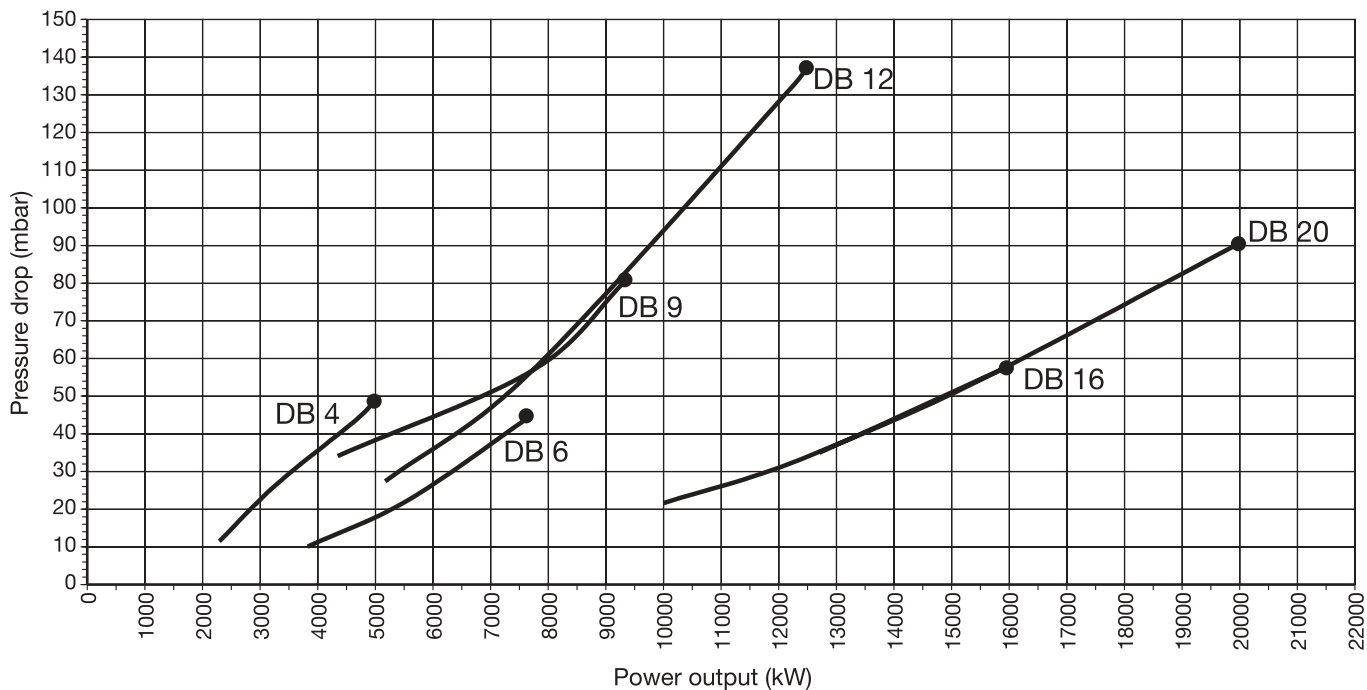

Burner head AIR pressure drop (including air damper - AIR temp = 40°C)
 DB - All versions except DB gas-Low NOx

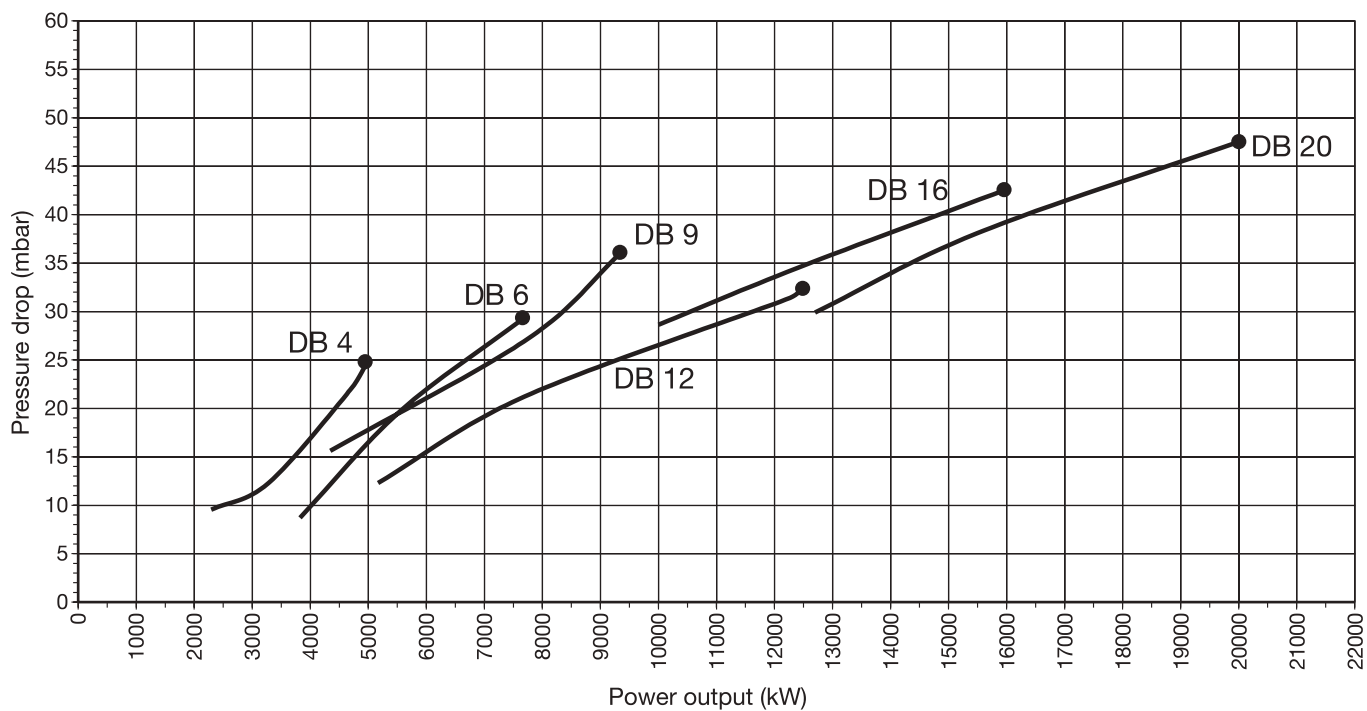

Overall Dimensions (mm)

All dimensions are approximate and mentioned just as an indication. Please refer to Riello Burners Technical Department for further detailed information.

BURNER

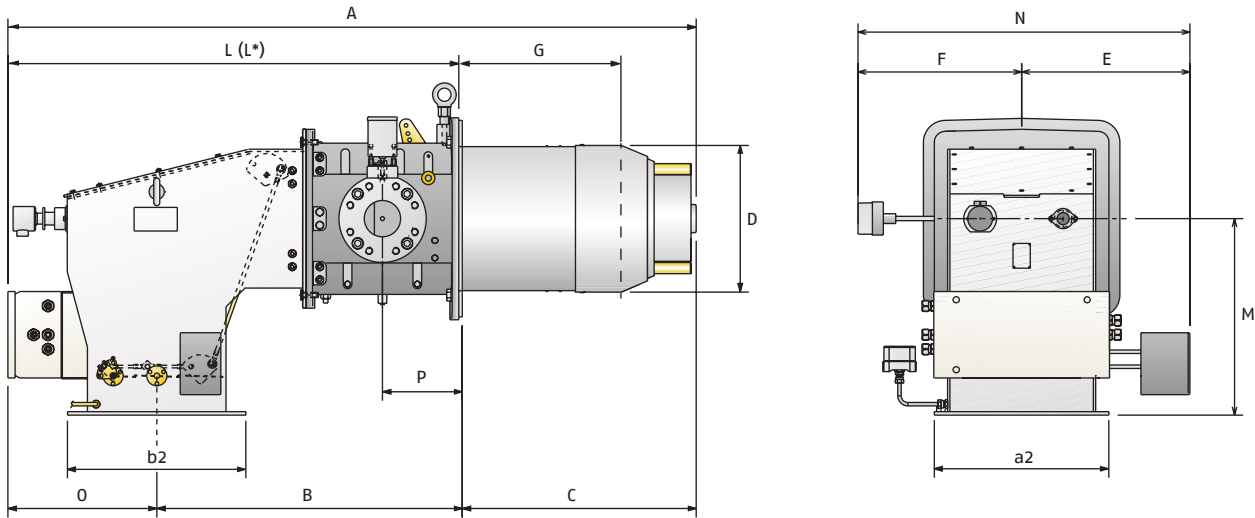

MODEL	A	B	C	D	E	F	G	L (L*)	M	N	O	P
DB 4	1577	700	536	313	385	375	370	1033 (1217)	450	760	341	183
DB 6	1577	700	536	363	385	375	400	1033 (1217)	450	760	341	183
DB 9	1857	851	662	413	420	333	484	1195 (1539)	550	753	344	208
DB 12	1857	851	662	456	420	333	465	1195 (1539)	550	753	344	208
DB 16	2080	852	797	544	486	448	544	1283 (1600)	761	934	431	258
DB 20	2080	852	797	590	486	448	562	1283 (1600)	761	934	431	258

L = gas version

L* = oil and dual fuel versions

a2 - b2 = see "Burner-boiler mounting flange" dimensions table

(*) Instructions about how to realize the fettling are reported in the manual of the burner in the chapter "Fixing to the boiler".

GAS CONNECTIONS

DB 4: DN 65
DB 6: DN 80

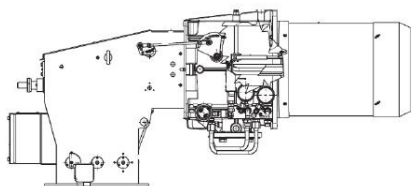

DN 65 gas connection from below
Elbow adapter DN 65 required
DN 80 gas connection from below
(for gas versions). Elbow adapter
DN 80 required.

DB 9 - 12: DN 80

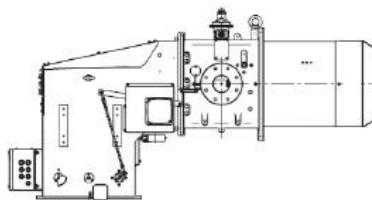

DN 80 gas connection from below
(for gas versions). Elbow adapter
DN 80 required.

DB 16 - 20: DN 100

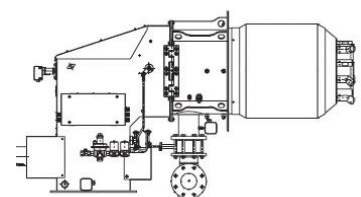

DN 100 gas connection from the side
Elbow 100/100 adapter already included
as standard equipment.

BURNER - BOILER MOUNTING FLANGE

AIR DUCT CONNECTION

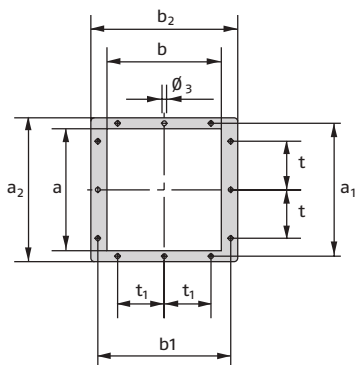

FIXING TO THE BOILER

DB 4 - 6 - 9 - 12

DB 16 - 20

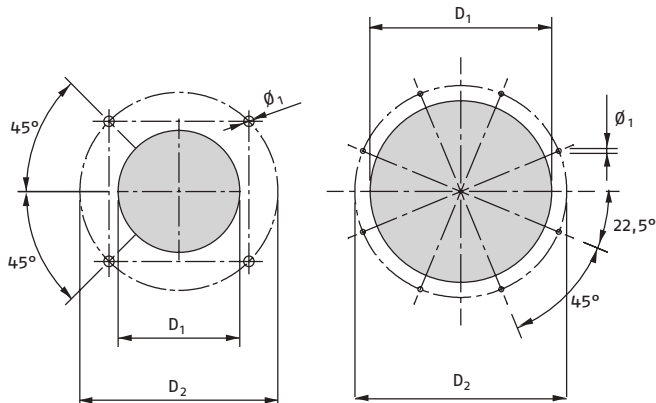

GAS SUPPLY

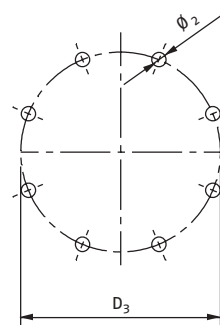

MODEL	a	a1	a2	b	b1	b2	D1	D2	D3	t	T1	Ø1	Ø2	Ø3
DB 4	329	370	400	308	370	409	350	452	145 - DN 65	130	130	M18	4x45° M16	13
DB 6	329	370	400	308	370	409	380	495	160 - DN80	130	130	M18	M16	13
DB 9	436	476	506	400	440	470	420	608	160 - DN 80	200	180	M20	M18	11
DB 12	436	476	506	400	440	470	465	608	160 - DN 80	200	180	M20	M18	11
DB 16	562	620	652	452	510	542	560	700	180 - DN 100	260	205	M16	M18	11
DB 20	562	620	652	452	510	542	600	700	160 - DN 100	260	205	M16	M18	11

PACKAGING

Overall dimensions and weights to estimate the delivery.

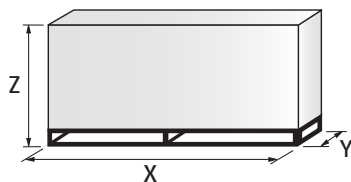

MODEL	X	Y	Z	kg
DB 4	2100	1000	1200	200
DB 6	2040	1180	1125	200
DB 9	2040	1180	1125	270
DB 12	2040	1180	1125	250
DB 16	2200	1000	1300	530
DB 20	2200	1000	1300	550

Burner Accessories

Nozzles for DB 4 - 6 - 9 - 12 - 16 - 20

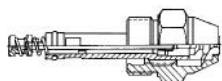

The nozzles must be ordered separately. The following table shows the features and codes on the basis of the maximum required fuel output. One nozzle required for each burner, able to guarantee the calculated oil delivery.

BURNER	ton/h*	Rated delivery kg/h	Nozzles type W2 - 45° code	Rated delivery kg/h	Nozzles type B5 - 45° - AA code
DB 4 - 6 - 9	3	200	3045438	200	3009800
		225	3045440	225	3009801
		250	3045442	250	3009802
	4	275	3045444	275	3009803
		300	3045446	300	3009804
		325	3045448	325	3009805
	5	350	3045450	350	3009806
		375	3045452	375	3009807
	6	400	3045454	400	3009808
		425	3045455	425	3009809
		450	3045456	450	3009810
	DB 6 - 9		475	3045457	475
500			3045458	500	3009812
525			3045459	525	3009813
8		550	3045460	550	3009814
		575	3045461	575	3009815
		600	3045462	600	3009816
		650	3045463	650	3009817
		700	3045464	700	3009818
DB 9		750	3045465	750	3009819
				800	3009820
	12			850	3009821
DB 12					
DB 12 -16					
DB 12 - 16 -20	15				
	16				
DB 16 - 20	18				
	20				
DB 20	22				
	25				

Nozzles:

W2 maximum modulating ratio 1:4 (interchangeable with B5)

B5 maximum modulating ratio 1:5 (interchangeable with W2)

CT5 maximum modulating ratio 1:5 bigger shape

22N1 maximum modulating ratio 1:5 (for special applications)

*steam boiler size according to:

N.C.V. heavy oil = 11,16 kWh/kg

combustion air = 50°C

1 ton/h = 775 kW (eff = 90%)

For steam/air assisted atomizing, special nozzles available on demand.

BURNER	ton/h*	Rated delivery kg/h	Nozzles type CT5 - 45° code	Rated delivery kg/h	Nozzles type 22N1 - 45° code	
DB 4 - 6 - 9	3			300	20091723	
				350	20091724	
				400	20091725	
	4			450	20091726	
				500	20091727	
				550	20091728	
				600	20091729	
	5			650	20091730	
		6			700	20091731
					750	20091732
DB 6 - 9				800	20091733	
				850	20091734	
				900	20091735	
				950	20091736	
	8			1000	20091737	
				1100	20091738	
				1200	20091739	
				1300	20091740	
	10			1400	20091741	
				1500	20091742	
DB 9						
	12					
DB 12		700	20006462			
DB 12 -16		800	20006465			
DB 12 - 16 -20		900	20006468			
	15	1000	20006469			
	16	1100	20006470			
DB 16 - 20		1200	20006471			
	18	1300	20006472			
	20	1400	20006473			
		1500	20006474			
DB 20	22	1600	20006475			
		1700	20006476			
	25	1800	20006477			

Nozzles:

W2 maximum modulating ratio 1:4 (interchangeable with B5)

B5 maximum modulating ratio 1:5 (interchangeable with W2)

CT5 maximum modulating ratio 1:5 bigger shape

22N1 maximum modulating ratio 1:5 (for special applications)

*steam boiler size according to:

N.C.V. heavy oil = 11,16 kWh/kg

combustion air = 50°C

1 ton/h = 775 kW (eff = 90%)

For steam/air assisted atomizing, special nozzles available on demand.

HIGH PRESSURE FLEXIBLE TUBES



In order to facilitate the connection of the burner to the fuel line adduction there are flexible tubes available according to the following table.

BURNER	TUBE DIAMETER	TUBE LENGTH (mm)	MAXIMUM WORKING PRESSURE (bar)	TUBE CODE
DB 4 - 6	1/2"	1500	40	3094227
DB 9 - 12 - 16 - 20	3/4"	2000	40	3094226

HIGH PRESSURE OIL FILTER



In order to protect the hydraulic circuit of the burner from the possible presence of particles in the combustion line, these following filters are available.

BURNER	FILTER DIAMETER	FILTERING DEGREE (µm)	FILTER CODE
DB 4 - 6	1/2"	500	3091881
DB 9 - 12 - 16 - 20	3/4"	500	in progress

CIRCULATION GROUP (BY-PASS VALVE)



If the burner is far away from the pumping group it is possible to install a circulation group that allows the circulates of the heated fuel during the stand-by phase.

BURNER	GROUP DIAMETER	GROUP CODE
DB 4 - 6	1/2"	in progress
DB 9 - 12 - 16 - 20	3/4"	in progress

CHECK VALVE

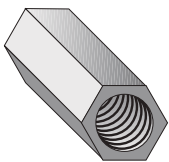

In order to avoid fuel return, that could damage the hydraulic circuit, "check valve" are available.

BURNER	VALVE DIAMETER	VALVE CODE
DB 4 - 6	1/2"	in progress
DB 9 - 12 - 16 - 20	3/4"	3012660

POTENTIOMETER KIT



Depending on the servomotor fitted to the burner, a three-pole potentiometer (1000 Ω) can be installed to check the position of the servomotor. The KITS available for the various burners are listed below.

BURNER	POTENTIOMETER KIT CODE
DB 4 - 6 - 9 - 12 - 16 - 20	3010021

Specification

DESIGNATION OF VERSIONS

A specific index guides your choice of burner from the various models available in the DB series. Follows a clear and detailed specification description of the product.

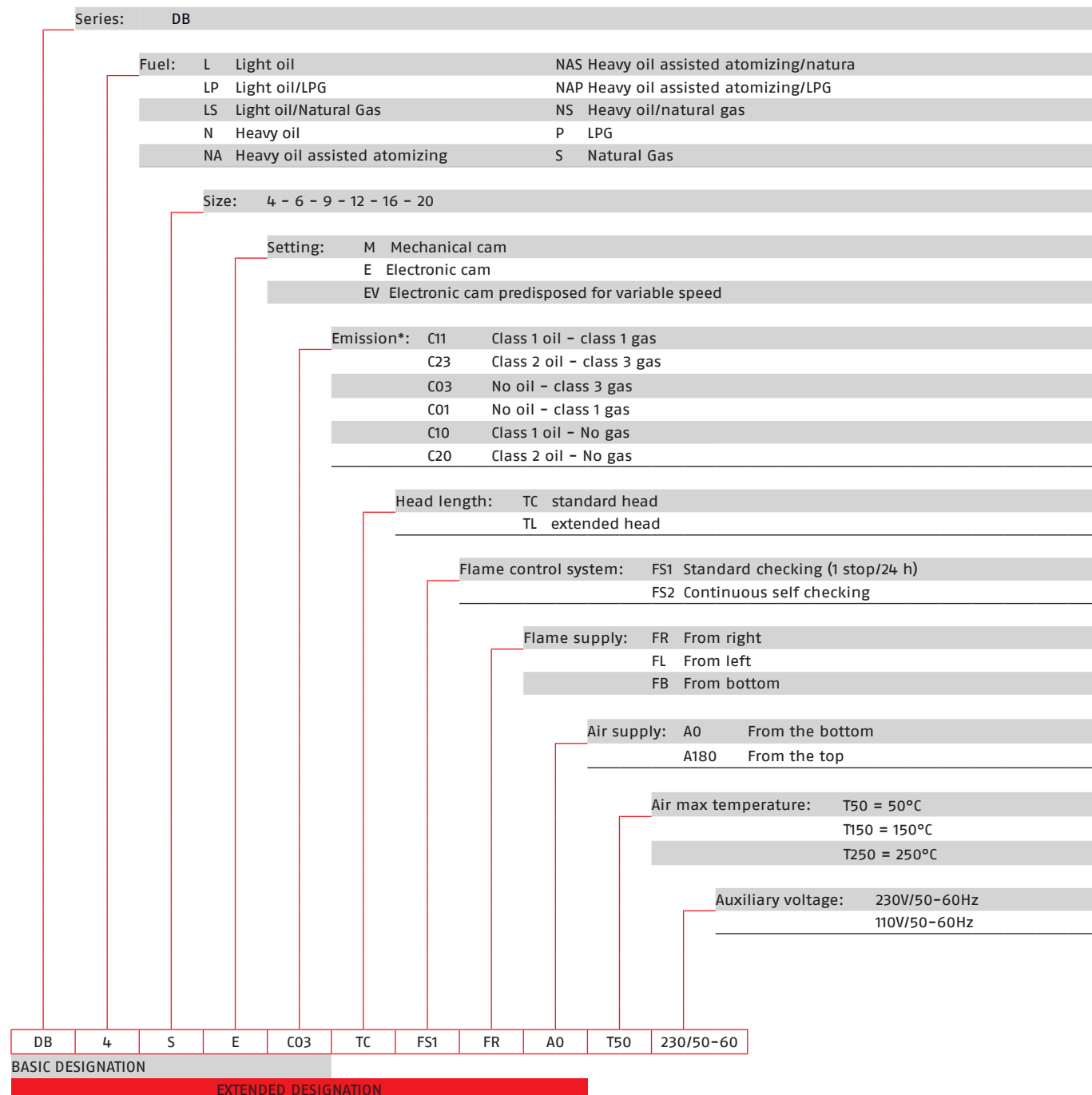

* Estimated, emissions values, considering a hot water boiler with thermal load of 1,1 MW/m³
 Guaranteed values to be confirmed after the verification of the combustion chamber characteristics

AVAILABLE BURNER MODELS

In the following table you can find the DB models available. Further versions are available on demand (heavy oil air/steam atomising models, preheated air up to 250°C construction, specific equipment and many others). For other low NOx versions, please contact Riello Burners Headquarter.

		MODEL **					FUEL		HEAT OUTPUT *		
									(kW)	OIL (kg/h)	GAS (Nm ³ /h)
LOW NOx MODELS	DB 4	SE	TC	A	0	FS1	230/50-60 Hz	Natural gas	1000/2500-5000	-	500
	DB 4	SE	TC	A	180	FS1	230/50-60 Hz	Natural gas		-	500
	DB 6	SE	TC	A	0	FS1	230/50-60 Hz	Natural gas	1400/4000-7800	-	780
	DB 6	SE	TC	A	180	FS1	230/50-60 Hz	Natural gas		-	780
	DB 9	SE	TC	A	0	FS1	230/50-60 Hz	Natural gas	1500/5000-9500	-	950
	DB 9	SE	TC	A	180	FS1	230/50-60 Hz	Natural gas		-	950
	DB 12	SE	TC	A	0	FS1	230/50-60 Hz	Natural gas	1700/7000-12500	-	1250
	DB 12	SE	TC	A	180	FS1	230/50-60 Hz	Natural gas		-	1250
	DB 16	SE	TC	A	0	FS1	230/50-60 Hz	Natural gas	2500/8000-16000	-	1600
	DB 16	SE	TC	A	180	FS1	230/50-60 Hz	Natural gas		-	1600
OTHER MODELS AVAILABLE	DB 20	SE	TC	A	0	FS1	230/50-60 Hz	Natural gas	3000/10000-20000	-	2000
	DB 20	SE	TC	A	180	FS1	230/50-60 Hz	Natural gas		-	2000
	DB 4	SM	TC	A	0	FS1	230/50-60 Hz	Natural gas		-	500
	DB 4	SM	TC	A	180	FS1	230/50-60 Hz	Natural gas		-	500
	DB 4	LE	TC	A	0	FS1	230/50-60 Hz	Light oil		422	-
	DB 4	LE	TC	A	180	FS1	230/50-60 Hz	Light oil		422	-
	DB 4	LSE	TC	A	0	FS1	230/50-60 Hz	Light oil / Natural gas		422	500
	DB 4	LSE	TC	A	180	FS1	230/50-60 Hz	Light oil / Natural gas	1000/2500-5000	422	500
	DB 4	LSM	TC	A	0	FS1	230/50-60 Hz	Light oil / Natural gas		422	500
	DB 4	LSM	TC	A	180	FS1	230/50-60 Hz	Light oil / Natural gas		422	500
	DB 4	NM	TC	A	0	FS1	230/50-60 Hz	Heavy oil		450	-
	DB 4	NM	TC	A	180	FS1	230/50-60 Hz	Heavy oil		450	-
	DB 4	NSM	TC	A	0	FS1	230/50-60 Hz	Heavy oil / Natural gas		450	500
	DB 4	NSM	TC	A	180	FS1	230/50-60 Hz	Heavy oil / Natural gas		450	500
	DB 6	SM	TC	A	0	FS1	230/50-60 Hz	Natural gas		-	780
	DB 6	SM	TC	A	180	FS1	230/50-60 Hz	Natural gas		-	780
	DB 6	LE	TC	A	0	FS1	230/50-60 Hz	Light oil		658	-
	DB 6	LE	TC	A	180	FS1	230/50-60 Hz	Light oil		658	-
	DB 6	LSE	TC	A	0	FS1	230/50-60 Hz	Light oil / Natural gas		658	780
	DB 6	LSE	TC	A	180	FS1	230/50-60 Hz	Light oil / Natural gas	1400/4000-7800	658	780
	DB 6	LSM	TC	A	0	FS1	230/50-60 Hz	Light oil / Natural gas		658	780
	DB 6	LSM	TC	A	180	FS1	230/50-60 Hz	Light oil / Natural gas		658	780
	DB 6	NM	TC	A	0	FS1	230/50-60 Hz	Heavy oil		703	-
	DB 6	NM	TC	A	180	FS1	230/50-60 Hz	Heavy oil		703	-
DB 6	NSM	TC	A	0	FS1	230/50-60 Hz	Heavy oil / Natural gas		703	780	
DB 6	NSM	TC	A	180	FS1	230/50-60 Hz	Heavy oil / Natural gas		703	780	
DB 9	SM	TC	A	0	FS1	230/50-60 Hz	Natural gas		-	950	
DB 9	SM	TC	A	180	FS1	230/50-60 Hz	Natural gas	1500/5000-9500	-	950	
DB 9	LE	TC	A	0	FS1	230/50-60 Hz	Light oil		801	-	
DB 9	LE	TC	A	180	FS1	230/50-60 Hz	Light oil		801	-	

* Max capacity is referred to:

Light oil net calorific value 11,8 kWh/kg - 10200 kcal/kg - Viscosity at 20°C 4-6 mm²/s (cSt)

Heavy oil net calorific value 11,1-11,3 kWh/kg - 9545-9720 kcal/kg - Viscosity at 20°C 500 mm²/s (cSt)

G20 net calorific value 10 kWh/Nm³ - Density 0,71 kg/Nm³

G25 net calorific value 8,6 kWh/Nm³ - Density 0,78 kg/Nm³

LPG net calorific value 25,8 kWh/Nm³ - Density 2,02 kg/Nm³

** FS1 operation as standard. FS2 on demand.

	MODEL **						FUEL	HEAT OUTPUT *			
								(kW)	OIL (kg/h)	GAS (Nm ³ /h)	
OTHER MODELS AVAILABLE	DB 9	LSE	TC	A	0	FS1	230/50-60 Hz	Light oil / Natural gas	1500/5000-9500	801	950
	DB 9	LSE	TC	A	180	FS1	230/50-60 Hz	Light oil / Natural gas		801	950
	DB 9	LSM	TC	A	0	FS1	230/50-60 Hz	Light oil / Natural gas		801	950
	DB 9	LSM	TC	A	180	FS1	230/50-60 Hz	Light oil / Natural gas		801	950
	DB 9	NM	TC	A	0	FS1	230/50-60 Hz	Heavy oil		856	-
	DB 9	NM	TC	A	180	FS1	230/50-60 Hz	Heavy oil		856	-
	DB 9	NSM	TC	A	0	FS1	230/50-60 Hz	Heavy oil / Natural gas		856	950
	DB 9	NSM	TC	A	180	FS1	230/50-60 Hz	Heavy oil / Natural gas		856	950
	DB 12	SM	TC	A	0	FS1	230/50-60 Hz	Natural gas	1700/7000-12500	-	1250
	DB 12	SM	TC	A	180	FS1	230/50-60 Hz	Natural gas		-	1250
	DB 12	LE	TC	A	0	FS1	230/50-60 Hz	Light oil		1054	-
	DB 12	LE	TC	A	180	FS1	230/50-60 Hz	Light oil		1054	-
	DB 12	LSE	TC	A	0	FS1	230/50-60 Hz	Light oil / Natural gas		1054	1250
	DB 12	LSE	TC	A	180	FS1	230/50-60 Hz	Light oil / Natural gas		1054	1250
	DB 12	LSM	TC	A	0	FS1	230/50-60 Hz	Light oil / Natural gas		1054	1250
	DB 12	LSM	TC	A	180	FS1	230/50-60 Hz	Light oil / Natural gas		1054	1250
	DB 12	NM	TC	A	0	FS1	230/50-60 Hz	Heavy oil	2500/8000-16000	1126	-
	DB 12	NM	TC	A	180	FS1	230/50-60 Hz	Heavy oil		1126	-
	DB 12	NSM	TC	A	0	FS1	230/50-60 Hz	Heavy oil / Natural gas		1126	1250
	DB 12	NSM	TC	A	180	FS1	230/50-60 Hz	Heavy oil / Natural gas		1126	1250
	DB 16	SM	TC	A	0	FS1	230/50-60 Hz	Natural gas		-	1600
	DB 16	SM	TC	A	180	FS1	230/50-60 Hz	Natural gas		-	1600
	DB 16	LE	TC	A	0	FS1	230/50-60 Hz	Light oil		1349	-
	DB 16	LE	TC	A	180	FS1	230/50-60 Hz	Light oil		1349	-
	DB 16	LSE	TC	A	0	FS1	230/50-60 Hz	Light oil / Natural gas	3000/10000-20000	1349	1600
	DB 16	LSE	TC	A	180	FS1	230/50-60 Hz	Light oil / Natural gas		1349	1600
	DB 16	LSM	TC	A	0	FS1	230/50-60 Hz	Light oil / Natural gas		1349	1600
	DB 16	LSM	TC	A	180	FS1	230/50-60 Hz	Light oil / Natural gas		1349	1600
DB 16	NM	TC	A	0	FS1	230/50-60 Hz	Heavy oil	1441		-	
DB 16	NM	TC	A	180	FS1	230/50-60 Hz	Heavy oil	1441		-	
DB 16	NSM	TC	A	0	FS1	230/50-60 Hz	Heavy oil / Natural gas	1441		1600	
DB 16	NSM	TC	A	180	FS1	230/50-60 Hz	Heavy oil / Natural gas	1441		1600	
DB 20	SM	TC	A	0	FS1	230/50-60 Hz	Natural gas	3000/10000-20000	-	2000	
DB 20	SM	TC	A	180	FS1	230/50-60 Hz	Natural gas		-	2000	
DB 20	LE	TC	A	0	FS1	230/50-60 Hz	Light oil		1686	-	
DB 20	LE	TC	A	180	FS1	230/50-60 Hz	Light oil		1686	-	
DB 20	LSE	TC	A	0	FS1	230/50-60 Hz	Light oil / Natural gas		1686	2000	
DB 20	LSE	TC	A	180	FS1	230/50-60 Hz	Light oil / Natural gas		1686	2000	
DB 20	LSM	TC	A	0	FS1	230/50-60 Hz	Light oil / Natural gas		1686	2000	
DB 20	LSM	TC	A	180	FS1	230/50-60 Hz	Light oil / Natural gas		1686	2000	
DB 20	NM	TC	A	0	FS1	230/50-60 Hz	Heavy oil	3000/10000-20000	1802	-	
DB 20	NM	TC	A	180	FS1	230/50-60 Hz	Heavy oil		1802	-	
DB 20	NSM	TC	A	0	FS1	230/50-60 Hz	Heavy oil / Natural gas		1802	2000	
DB 20	NSM	TC	A	180	FS1	230/50-60 Hz	Heavy oil / Natural gas		1802	2000	

* Max capacity is referred to:

Light oil net calorific value 11,8 kWh/kg - 10200 kcal/kg - Viscosity at 20°C 4-6 mm²/s (cSt)

Heavy oil net calorific value 11,1-11,3 kWh/kg - 9545-9720 kcal/kg - Viscosity at 20°C 500 mm²/s (cSt)

G20 net calorific value 10 kWh/Nm³ - Density 0,71 kg/Nm³

G25 net calorific value 8,6 kWh/Nm³ - Density 0,78 kg/Nm³

LPG net calorific value 25,8 kWh/Nm³ - Density 2,02 kg/Nm³

** FS1 operation as standard. FS2 on demand.

Other versions are available on request.

SPECIFICATION

STATE OF SUPPLY

ALL BURNERS

Dual block forced draught burner, two stages progressive or modulating operation (with a kit), separate supply, fully automatic, made up of:

- Air damper for air setting with variable profile cam controlled by a servomotor (version /M – mechanical cam)
- Air damper for air setting with air servomotor managed by microprocessor (version /E – electronic cam)
- Variable geometry combustion head that can be set according the required output
- Combustion head servomotor managed by microprocessor (version /E – electronic cam DB16-20 only)
- Pilot burner with two gas valves and pressure regulator (as standard on DB9-12-16-20 only)
- Minimum air pressure switch
- Flame inspection window
- Electrical interface box with ignition transformer inside
- Opening hinge to have easier combustion head inspection and maintenance
- IP54 protection level.

OIL BURNER

- Photocell for flame detection
- Nozzle pipe
- Safety nozzle valve
- Oil lance without nozzle (nozzle must be ordered separately)
- Valves group with safety oil valves
- Oil capacity regulator controlled by air servomotor linkage (version /M – mechanical cam)
- Oil capacity regulator with servomotor managed by microprocessor (version /E – electronic cam)
- Maximum oil pressure switch on the return circuit
- Pressure gauge on delivery and return circuit.

Conforming to:

- 2004/108/EC directive (electromagnetic compatibility)
- 2006/95/EC directive (low voltage)
- 2006/42/EC directive (machinery)
- EN 267 (liquid fuel burners).

Standard equipment:

- screws for fixing the burner flange to the boiler
- thermal screen
- instruction handbook for installation, use and maintenance
- spare parts catalogue.

Available accessories to be ordered separately:

- flexible tubes
- nozzles
- high pressure oil filter
- circulation group (by-pass valve)
- check valve
- potentiometer kit for the servomotor.

GAS BURNER

- Photocell for flame detection
- Maximum gas pressure switch
- Butterfly gas valve controlled by air servomotor linkage (version /M – mechanical cam)
- Butterfly gas valve with servomotor managed by microprocessor (version /E – electronic cam)
- Gas pressure test point to the combustion head.

Conforming to:

- 2014/35/UE directive (electromagnetic compatibility)
- 2014/30/UE directive (low voltage)
- 2009/142/EC directive (gas)
- EN 676 (gas burners).

Standard equipment:

- screws for fixing the burner flange to the boiler
- thermal screen
- screws for fixing the gas train flange to the burner
- gas train gasket
- instruction handbook for installation, use and maintenance
- spare parts catalogue
- high voltage burner ignition for DB 4÷6
- pilot burner ignition for DB 9÷20 (for DB 4÷6 on demand).

Available accessories to be ordered separately:

- potentiometer kit for the servomotor.
- adapter for gas train DB 4-6-9-12 models

DUAL FUEL BURNER (OIL/GAS)

- Photocell for flame detection
- Nozzle pipe
- Safety nozzle valve
- Oil lance without nozzle (nozzle must be ordered separately)
- Valves group with safety oil valves
- Oil capacity regulator controlled by air servomotor linkage (version /M – mechanical cam)
- Oil capacity regulator with servomotor managed by microprocessor (version /E – electronic cam)
- Maximum oil pressure switch on the return circuit
- Pressure gauge on delivery and return circuit
- Maximum gas pressure switch
- Butterfly gas valve controlled by air servomotor linkage (version /M – mechanical cam)
- Gas/oil servomotor managed by microprocessor (version /E – electronic cam) for butterfly gas valve / oil capacity regulator control
- Gas pressure test point to the combustion head.

Conforming to:

- 2004/108/EC directive (electromagnetic compatibility)
- 2006/95/EC directive (low voltage)
- 2006/42/EC directive (machinery)
- 2009/142/EC directive (gas)
- EN 267 (liquid fuel burners)
- EN 676 (gas burners)

Standard equipment:

- screws for fixing the burner flange to the boiler
- thermal screen
- screws for fixing the gas train flange to the burner
- gas train gasket
- instruction handbook for installation, use and maintenance
- spare parts catalogue
- high voltage burner ignition for DB 4÷6
- pilot burner ignition for DB 9÷20 (for DB 4÷6 on demand).

Available accessories to be ordered separately:

- flexible tubes
- nozzles
- high pressure oil filter
- circulation group (by-pass valve)
- check valve
- potentiometer kit for the servomotor
- adapter for gas train DB 4-6-9-12 models

Riello Burners a world of experience in every burner we sell.

05/2016
TSC0066UK03



[1]

Across the world, Riello sets the standard in reliable and high efficiency burner technology.

With burner capacity from 5 kW to 48 MW, Riello gas, oil, dual fuel and Low Nox burners deliver unbeatable performance across the full range of residential and commercial heating applications, as well as in industrial processes.

With headquarter in Legnago, Italy, Riello has been manufacturing premium quality burners for over 90 year. The manufacturing plant is equipped with the most innovative systems of assembling lines and modern manufacturing cells for a quick and flexible response to the market.



[2]

Besides, the Riello Combustion Research Centre, located in Angiari, Italy, represents one of the most modern facility in Europe and one of the most advanced in the world for the development of the combustion technology.

Today, the company's presence on worldwide markets is distinguished by a well-constructed and efficient sales network, alongside many important Training Centres located in various countries to meet its customers' needs. Riello has 13 operational branches abroad (in Europe, America and Asia), with customers in over 60 countries.

[1] BURNERS PRODUCTION PLANT
S. PIETRO, LEGNAGO (VERONA) - ITALIA

[2] HEADQUARTER BURNERS DIVISION
S. PIETRO, LEGNAGO (VERONA) - ITALIA

COMBUSTION TECHNOLOGY

ENQUIRIES

National Tel: +27 21 715 3171

Email: info@combustiontechnology.co.za

www.combustiontechnology.co.za



Since the Company is constantly engaged in the production improvement, the aesthetic and dimensional features, the technical data, the equipment and the accessories can be changed. This document contains confidential and proprietary information of RIELLO S.p.A. Unless authorised, this information shall not be divulged, nor duplicated in whole or in part.

RIELLO